

ADVANTAGE![™]

AST
RESEARCH INC.

*PC-AT Multifunction
Expansion Board Offering
up to 3 Mb of Memory and
Powerful I/O Capabilities*

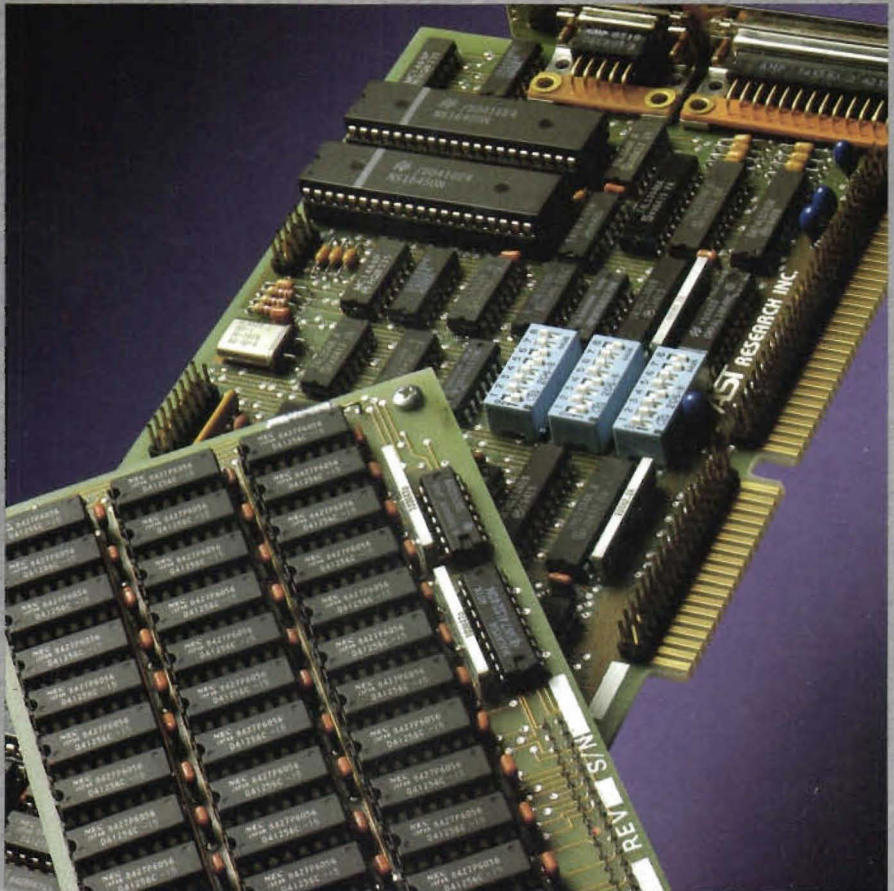

User's Manual

Advantage!
Memory Expansion
and I/O Board
for the
IBM Personal Computer AT

User's Manual
000179-001 C
June, 1985

AST Research, Inc.
Irvine, California
(714) 863-1333

Third Edition (June, 1985)

IBM, PC/AT, and PC-DOS are registered trademarks of International Business Machines Corporation.

XENIX is a trademark of Microsoft, Inc.

Advantage! and Advantage-Pak are trademarks of AST Research, Inc.

Changes are periodically made to the information contained in this manual; these changes will be incorporated into new editions.

A Product Comment Form is provided at the back of this publication. If this form has been removed, please address your comments to: AST Research, Inc., Attention: Technical Publications, 2121 Alton Ave., Irvine, CA 92714. AST Research may use or distribute any of the information you supply in any way it deems appropriate without incurring any obligations whatsoever.

Copyright © 1984 AST Research, Inc. All rights are reserved, including those to reproduce this book or parts thereof in any form without permission in writing from AST Research, Inc.

Warranty Registration Form

000134-001 A

Name Mr. / Miss Ms. / Miss		First	Company	Phone
Street		City	State	Zip Code
Product Model No. (See Endflap of Box)		Purchase Date (mm/dd/yy)		No. of PCs at this Address
Serial No. (See Endflap of Box or Board)		Purchased From		

In order to help us meet your future needs, please fill out the lower portion of this form.

System Configuration	Manufacturer's Name
<input type="checkbox"/> Multifunction/Memory _____	Type of PC Used _____
<input type="checkbox"/> Graphics (Color? ___) _____	For Data Communication Products:
<input type="checkbox"/> Data Communication _____	Host System _____
<input type="checkbox"/> Network Card _____	For PCnet or PCnet II Users:
<input type="checkbox"/> Modem (___ Baud) _____	Version of Network Software Being Used: _____
<input type="checkbox"/> Hard Disk (___ MB) _____	See Diskette Label _____

Please complete and return this card within (10) days of purchase. AST products are warranted for one year from date of purchase. If you encounter a problem with an AST product that is under warranty, you should call AST to receive a Return Authorization Number prior to returning the product for service. It is essential that we have your warranty card on file in order for us to provide repair service or replacement at no charge to you.

NO POSTAGE
NECESSARY
IF MAILED
IN THE
UNITED STATES



BUSINESS REPLY MAIL

FIRST CLASS

PERMIT NO. 7379

IRVINE, CA

POSTAGE WILL BE PAID BY ADDRESSEE

AST Research, Inc.

Attn: Product Marketing
2121 Alton Avenue
Irvine, California 92714

Extended Warranty Registration Record

If you wish to obtain one additional year of limited warranty beyond the standard one-year warranty, complete the lower portion of this card, detach it, and return with U.S. \$50.00 to:

AST Research, Inc.
Attn: Accounting Dept.
2121 Alton Ave.
Irvine, CA 92714

Model No. _____ Serial No. _____

Keep this portion for your records.

Date Extended Warranty Form Returned to AST Research _____

Extended Warranty Registration

Return this card with U.S. \$50.00 to obtain an additional one-year limited warranty beyond the standard one-year warranty.

Name _____ Model No. (See Endflap of Box) _____

Street _____ Serial No. (See Endflap of Box or Board) _____

City, State, Zip _____

Date of Purchase (mm/dd/yy) _____ Purchased From _____



TABLE OF CONTENTS

SECTION 1. INTRODUCING THE <i>ADVANTAGE!</i>	1-1
1.1 Inventory Checklist	1-2
1.2 Related Reading	1-2
1.3 What's In This Manual?	1-3
SECTION 2. OVERVIEW	2-1
2.1 Factory Configuration	2-1
2.2 Standard Features	2-3
2.3 Optional Features	2-3
2.4 AT System Requirements	2-4
SECTION 3. CONFIGURATION AND INSTALLATION ...	3-1
3.1 Before You Begin	3-2
3.2 Configuring the <i>Advantage!</i>	3-2
STEP 1—Configuring the Memory Size	3-4
STEP 2—Configuring the Memory Starting Address	3-7
Option #1: Split Memory Addressing in a 256K AT	3-8
Option #2: Split Memory Addressing in a 512K AT	3-9
Option #3: Contiguous Memory Addressing in a 512K or 640K AT	3-11
STEP 3—Selecting Error Checking	3-12
STEP 4—Configuring the Serial Ports	3-14
STEP 5—Configuring the Parallel Port	3-16
STEP 6—Configuring the Game Port	3-17
STEP 7—Installing the <i>Advantage!</i> in the AT ...	3-19
STEP 8—Run the AT SETUP and Diagnostic Program	3-24
SECTION 4. MEMORY CONFIGURATION	4-1
4.1 AT Memory Addressing	4-1
4.1.1 The 640K Base Area—Split Memory Addressing	4-3

TABLE OF CONTENTS

(Continued)

- 4.1.2 The 15 Megabyte Expansion
 - Memory Area 4-6
- 4.1.3 AT System Board Memory Configuration . . 4-6
- 4.2 Setting the Starting Memory Address of the *Advantage!* 4-7
- 4.3 If You Have Other Memory Cards 4-7
 - 4.3.1 Installing a Card "Below" the *Advantage!* 4-8
 - 4.3.2 Installing a Card "Above" the *Advantage!* 4-9
- 4.4 Installing Additional Memory on the *Advantage!* 4-10
 - 4.4.1 Memory Chip Specifications 4-10
 - 4.4.2 Populating the Memory Rows with Memory Chips 4-11
 - 4.4.3 Mixing 64K and 256K Memory Chips 4-11
- 4.5 Setting the Memory Size of the *Advantage!* 4-13
- SECTION 5. SERIAL PORTS 5-1**
 - 5.1 Technical Information About AT Serial Ports 5-1
 - 5.1.1 I/O Address and Interrupt Assignments . . . 5-2
 - 5.1.2 Serial Port Pinout Specifications 5-2
 - 5.1.3 Managing the *Advantage!* Serial Port Inputs 5-4
 - 5.1.4 Configuring External Serial Devices 5-6
 - 5.1.5 Programming the Serial Ports 5-6
 - 5.1.6 The AT Serial Port Controller 5-7
 - 5.2 *Advantage!* Serial Port Configuration 5-7
 - 5.3 *Advantage!* Factory Default Serial Port Configurations 5-9
 - 5.4 Installing *Advantage!* Serial Port #2 5-9
- SECTION 6. PARALLEL PRINTER PORT 6-1**
 - 6.1 Technical Information About AT Parallel Ports . . . 6-1
 - 6.1.1 I/O Address and Interrupt Assignments . . . 6-2

TABLE OF CONTENTS

(Continued)

6.1.2	Parallel Port Pinout Specifications	6-2
6.1.3	Configuring External Parallel Devices	6-2
6.1.4	Programming the Parallel Ports	6-2
6.2	<i>Advantage!</i> Parallel Port Configuration	6-4
6.3	<i>Advantage!</i> Factory Default Parallel Port Configuration	6-6

SECTION 7. GAME ADAPTER PORT	7-1	
7.1	Technical Information About the Game Port	7-1
7.1.1	I/O Address and Interrupt Assignments . . .	7-1
7.1.2	Game Adapter Port Pinouts	7-1
7.2	<i>Advantage!</i> Game Adapter Port Configuration . .	7-2
7.3	Software Compatibility	7-3
7.4	Game Port Diagnostic Testing	7-4
7.5	Installing the Game Port Adapter Upgrade Kit . .	7-4

APPENDICES

Appendix A.	Recommended Serial Port Wiring	A-1
Appendix B.	General Serial Interface Wiring Information . .	B-1
Appendix C.	Switching Between Parallel Printer Ports . . .	C-1
Appendix D.	<i>Advantage!</i> and AT Memory Configuration Information	D-1
Appendix E.	Configuring the AT System Board Memory . .	E-1

FIGURES

Figure 2-1.	<i>Advantage!</i> Board Layout	2-2
Figure 3-1.	Setting the <i>Advantage!</i> Memory Size	3-5
Figure 3-2.	Memory Size Example #1	3-6
Figure 3-3.	Memory Size Example #2	3-6

TABLE OF CONTENTS

(Continued)

Figure 3-4.	Split Memory Addressing in a 256K AT	3-8
Figure 3-5.	Split Memory Addressing in a 512K AT	3-10
Figure 3-6.	Contiguous Memory Addressing in 512K or 640K AT	3-11
Figure 3-7.	Enabling and Disabling Parity	3-13
Figure 3-8.	Game Port Enable	3-17
Figure 3-9.	AT System Board Memory Configuration . . .	3-20
Figure 3-10.	Serial Port #2 and Game Port Connector Locations	3-22
Figure 4-1.	AT System Memory Map	4-2
Figure 4-2.	Split Memory Addressing	4-5
Figure 4-3.	<i>Advantage!</i> Memory Row Configuration	4-11
Figure 4-4.	Switch Block #1 and Memory Rows	4-14
Figure 4-5.	Memory Size Example #1	4-15
Figure 4-6.	Memory Size Example #2	4-16
Figure 5-1.	DB9 to DB25 Serial Port Conversion Pinouts .	5-3
Figure 5-2.	Serial Port Interface Using DB9-DB25 Adapter Cable	5-3
Figure 5-3.	Serial Port Input Line Configuration Block	5-5
Figure 5-4.	Switch Block #2 and IRQ Enable Block Location	5-7
Figure 5-5.	Default Settings with One Serial Port	5-9
Figure 5-6.	Default Settings with Two Serial Ports	5-9
Figure 6-1.	Switch Block #2 and IRQ Enable Block Location	6-4
Figure 6-2.	Default Configuration of Parallel Port	6-6
Figure 7-1.	Game Adapter Port Enable/Disable Switch . . .	7-3
Figure B-1.	Ideal Case: DTE to DCE Interface	B-4
Figure B-2.	Typical DTE to DTE Interface	B-6
Figure B-3.	DTE to DTE (NEC 7700 Printer) Interface	B-7
Figure B-4.	Serial Interface Form	B-9
Figure E-1.	AT System Board Memory Configuration	E-2

TABLE OF CONTENTS

(Continued)

TABLES

Table 3-1. Configuration for <i>Advantage!</i> with One Serial Port	3-14
Table 3-2. Configuration for <i>Advantage!</i> with Two Serial Ports	3-15
Table 3-3. Parallel Port Configuration in AT with Color-Type Display Card	3-16
Table 3-4. Parallel Port Configuration in AT with Monochrome-Type Display Card	3-17
Table 5-1. AT Serial Port I/O Address & IRQ Assignments	5-2
Table 5-2. DB9 Serial Port Pinouts	5-2
Table 5-3. Configuration for <i>Advantage!</i> with One Serial Port	5-8
Table 5-4. Configuration for <i>Advantage!</i> with Two Serial Ports	5-8
Table 6-1. AT Parallel Port I/O & IRQ Assignments (with Monochrome-Type Display Card)	6-2
Table 6-2. AT Parallel Port I/O & IRQ Assignments (with Color-Type Display Card)	6-2
Table 6-3. AT Parallel Port Pinouts	6-3
Table 6-4. Parallel Port Configuration in AT with Monochrome-Type Display Card	6-5
Table 6-5. Parallel Port Configuration in AT with Color-Type Display Card	6-5
Table 7-1. Game Adapter Port Pinouts	7-2
Table D-1. Split Memory Addressing Memory Allocation ..	D-2
Table D-2. Switch Block #3 Settings (Starting Address) ...	D-3

(This page intentionally left blank)

SECTION 1

INTRODUCING THE *ADVANTAGE!*

The AST *Advantage!*[™] is a versatile multifunction enhancement product for the IBM Personal Computer (PC) AT. The *Advantage!* includes these features:

- Memory expansion upgradable to 1.5 Megabytes (MB) on the main board and 3 MB total using the Advantage-Pak piggyback memory module.
- “Split Memory Addressing” which allows the *Advantage!* to round out your AT base memory to 640K while also providing expansion memory at 1 Megabyte and above. This provides the greatest possible efficiency in AT memory usage.
- Compatibility with both 64K and 256K RAM chips for maximum flexibility in upgrading *Advantage!* memory. Total memory capacity of the *Advantage!* (with Advantage-Pak installed) is 768KB using 64K chips, or 3MB using 256K chips.
- Two RS-232 asynchronous serial communications ports; one standard and one optional.
- A parallel printer port.
- An optional game adapter port.

1.1 Inventory Checklist

Before you get started, check that your *Advantage!* package includes the following:

- *Advantage!* circuit board.
- Advantage-Pak piggyback circuit board (if applicable to your memory configuration).
- Serial port #2 interface ribbon cable and bracket (if the second serial port option is included on your *Advantage!* board).
- Game adapter port ribbon cable and bracket (if the game port option is included on your *Advantage!* board).

NOTE

Be sure to fill out your warranty card (located at the front of this manual) and mail it in.

1.2 Related Reading

This manual assumes some familiarity with the PC-DOS operating system and the IBM PC-AT hardware. All references to operating system commands and I/O port designations in this manual assume operation under a single-user, single-tasking version of the PC-DOS operating system.

You can find additional information in the following manuals for your IBM PC-AT:

- *Installation and Setup*
- *Guide to Operations*
- *Technical Reference*
- *Disk Operating System*
- *BASIC*

1.3 What's In This Manual?

Section 2 gives an overview of the *Advantage!* product, including a diagram locating all the important *Advantage!* features.

Section 3 describes how to configure the *Advantage!* and install it in your AT.

Section 4 describes *Advantage!* memory configuration in detail.

Section 5 describes the *Advantage!* serial ports in detail.

Section 6 describes the *Advantage!* parallel printer port in detail.

Section 7 describes the *Advantage!* game adapter port in detail.

Appendix A describes recommended wiring configurations for specific serial devices such as printers and modems.

Introducing the *Advantage!*

Appendix B is a “primer” on serial port interfaces.

Appendix C describes a utility program that routes printer output from one parallel port to another.

Appendix D lists all the possible settings for *Advantage!* Switch Block #3 (starting memory address).

Appendix E describes how to properly configure the AT system board for either 256K or 512K of system board memory.

SECTION 2

OVERVIEW

This section describes the standard and optional features of the *Advantage!*, as well as AT system requirements for *Advantage!* installation.

2.1 Factory Configuration

The *Advantage!* is shipped from the factory in this configuration:

- Parallel port configured as LPT1, for use in an AT with a color-type display card which does not have a built-in printer adapter port.
- Serial port #1 configured as COM1 using interrupt line IRQ4 (Standard).
- Serial port #2 configured as COM2 using interrupt line IRQ3 (Optional—disabled if not installed).
- Game port enabled (Optional—disabled if not installed).
- Split Memory Addressing enabled (factory setting may be for either 256K or 512K AT system board—check before installing).
- Memory size switches set as appropriate for the factory-installed RAM on your *Advantage!*.

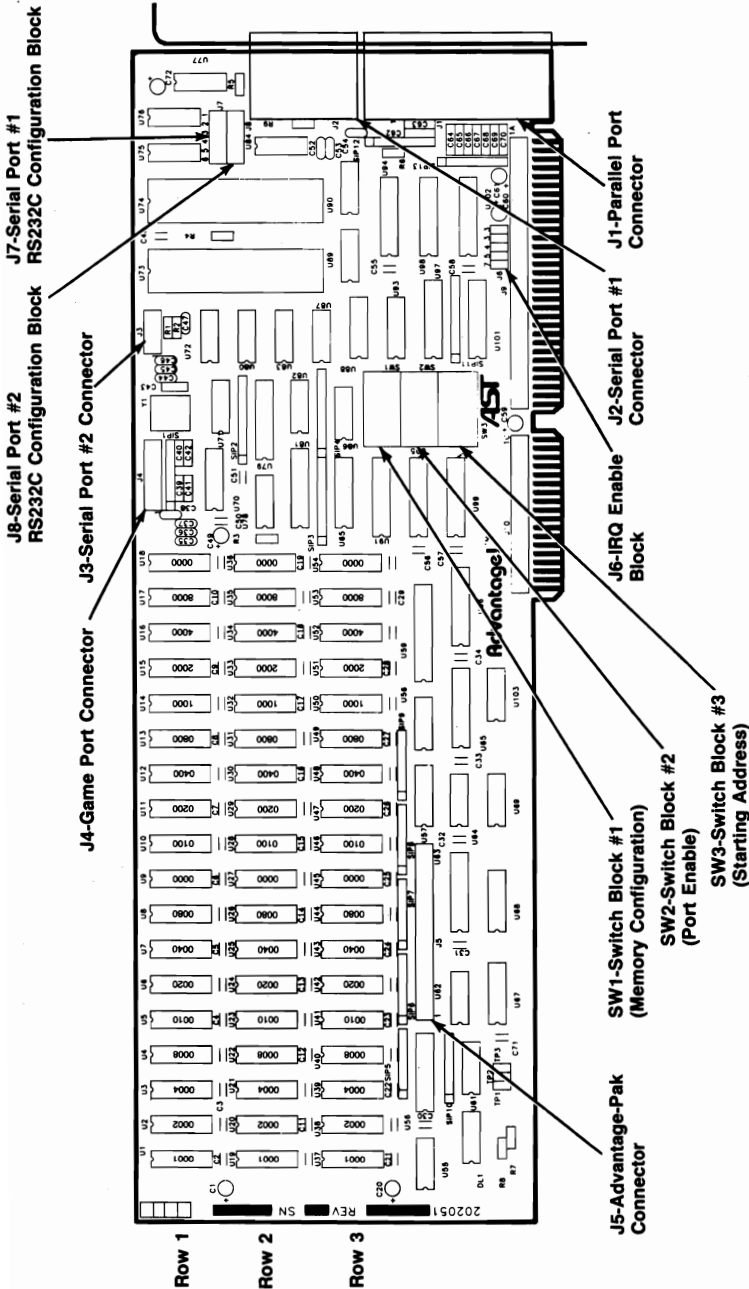

Figure 2-1. Advantage! Board Layout

2.2 Standard Features

These are the standard *Advantage!* features:

- A minimum of 128K bytes of Random Access Memory (RAM).
- An RS-232C serial port.
- A parallel printer port.

2.3 Optional Features

These options are available for your *Advantage!*:

- Memory expansion is available in increments of either 128KB (using 64K RAM chips) or 512KB (using 256K RAM chips) for up to a total of 1.5MB on the *Advantage!* main board.
- The *Advantage-Pak* piggyback memory module adds up to 1.5MB to this, making the maximum possible memory of the *Advantage!* package 3MB.
- A second serial port (AST Model No. ADV-000S) that can be configured as COM2.
- A game adapter port (AST Model No. ADV-000G) that can be used with one or two IBM-compatible joysticks or other acceptable cursor control device.

These options may be factory-installed, or you may install them yourself at a later date. Upgrade kits are available from your dealer.

NOTE

Although the AST Research *Advantage!* card is designed for easy user expansion, the warranty coverage applies only to the configuration of the board as originally shipped from the factory. Components added on at a later date are not warranted.

2.4 AT System Requirements

The *Advantage!* board and Advantage-Pak memory module are designed to be completely compatible with the IBM PC-AT. There are no special requirements for installing the *Advantage!* in the AT except those noted during the installation instructions.

All references to operating system commands and I/O port designations in this manual assume operation under a single-user, single-tasking version of the PC-DOS operating system.

SECTION 3

CONFIGURATION AND INSTALLATION

This section contains instructions for installing your *Advantage!* in most AT configurations. There are eight basic steps to follow when installing the *Advantage!*:

STEP 1—Configuring the Memory Size

STEP 2—Configuring the Starting Address

STEP 3—Selecting Error Checking

STEP 4—Configuring the Serial Ports

STEP 5—Configuring the Parallel Port

STEP 6—Configuring the Game Port

STEP 7—Installing the *Advantage!* in the AT

STEP 8—Running the AT's SETUP and Diagnostic Program

If you have more technical questions about a particular feature that are not addressed here, please refer to one of the following sections for further information:

Section 4: Memory Configuration

Section 5: Serial Port Configuration

Section 6: Parallel Port Configuration

Section 7: Game Port Configuration

3.1 BEFORE YOU BEGIN

- If your AT is equipped with a 256K system board, or if you are changing the AT system board memory configuration at this time, you must configure the system board according to the instructions contained in Installation Step 7 (or Appendix E) of this manual. Failing to do this will cause errors during the AT's power-on self test.

- "Base Memory" refers to the AT's 640K standard memory area, and is directly accessible by PC-DOS.

"Expansion Memory" refers to the AT's 15 Megabyte extended memory area, and is accessible via VDISK or other special software.

"Split Memory Addressing" means part of the *Advantage!* memory is rounding out the 640K base area, while the remaining memory provides expansion memory in the 15 Megabyte area.

"Contiguous Memory Addressing" means that all of the *Advantage!* memory is being used as expansion memory

Refer to Section 4 for further information on these terms.

- Unless otherwise noted, all references to the *Advantage!* include those cards which have the optional Advantage-Pak piggyback board installed.

3.2 Configuring the *Advantage!*

To configure the the *Advantage!*, you need to know these things:

- How much memory is installed on the *Advantage!*

- Where in the AT's memory range the *Advantage!* will operate
- Whether you want the *Advantage!* to check memory data for errors ("Parity Checking")
- How many serial and parallel ports your AT already has

This information is programmed into the *Advantage!* by setting switches and shorting plugs on the card. The following steps tell you how to do this.

If you have questions regarding *Advantage!* configuration that are not answered during the installation steps (such as how to mix 64K and 256K chips on the same board), please refer to the appropriate technical section of this manual.

STEP 1—Configuring the Memory Size

Figure 3-1 shows the settings for Switch Block #1 on the *Advantage!*. This switch tells the card how much memory it has and how the memory chips are configured.

The switch settings in Figure 3-1 are separated into six groups according to the number of memory rows installed on the *Advantage!*; 1 row of memory, 2 rows of memory, etc. Within each group, the settings are then broken down according to the number of rows populated with 128K (using 18 64K chips), and those populated with 512K (using 18 256K chips).

Examples of typical memory size switch configurations are shown in Figures 3-2 and 3-3.

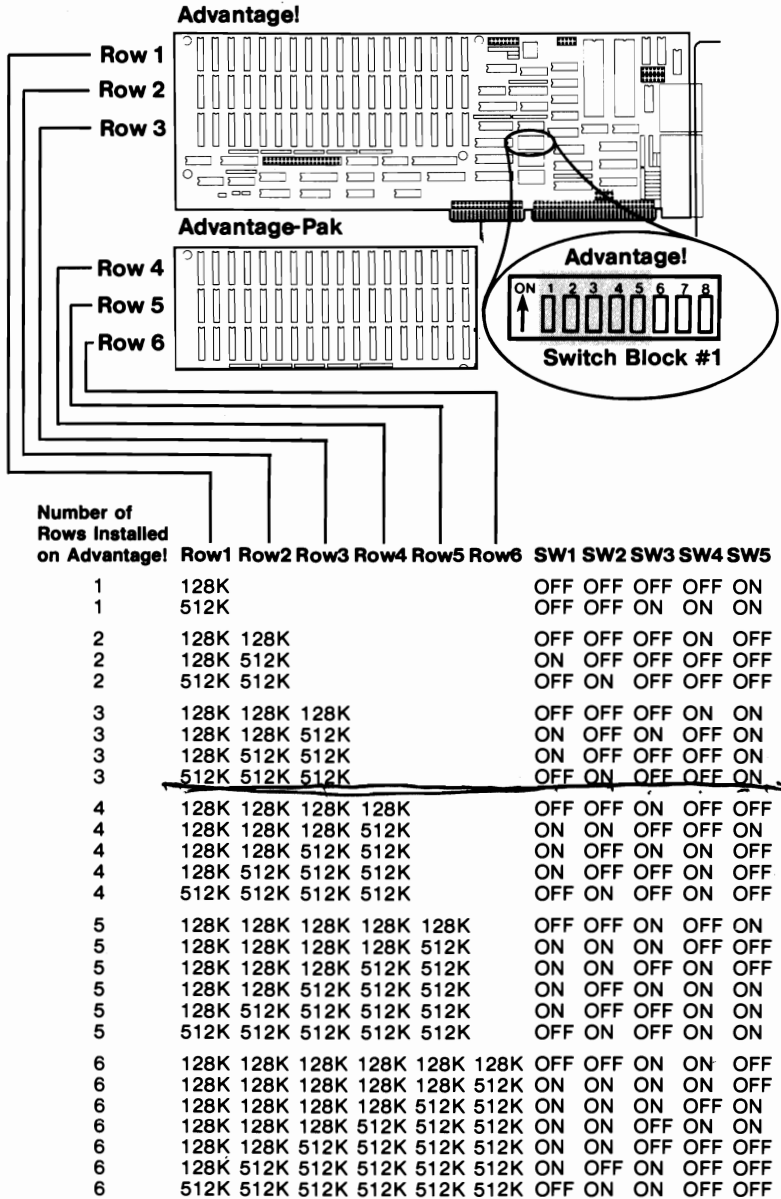

Figure 3-1. Setting the Advantage! Memory Size

Example 1: If your *Advantage!* has one row of memory consisting of 128K, you would use the first entry in the table, and set Switch Block #1 as shown in

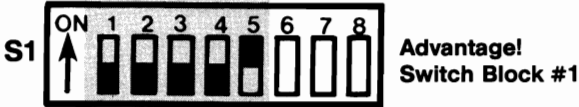

Figure 3-2. Memory Size Example #1

Example 2: If your *Advantage!* has four rows of memory (including the Advantage-Pak piggyback board), and the first row has 128K while rows 2, 3, and 4 have 512K, you would set Switch Block #1 as shown in Figure 3-3.

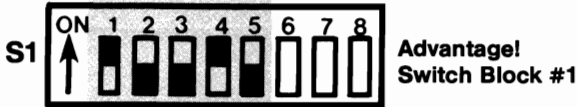

Figure 3-3. Memory Size Example #2

Set the switches to match the amount of memory on your *Advantage!*.

STEP 2—Configuring the Starting Memory Address

The next thing you need to tell the *Advantage!* is where its memory will be located in the AT's memory addressing range. This is done by configuring the settings of Switch Block #3 on the *Advantage!*.

When configuring Switch Block #3, note the following:

- If you are using no other memory cards in your AT, follow the instructions in this section.
- If you are using the IBM 128K memory card in your AT, follow the instructions in this section.
- If you are using any other memory cards in your AT (excluding the IBM 128K card), or if you are using more than one *Advantage!*, follow the instructions in Section 4.3, "If You Have Other Memory Cards".
- If you have 256K on your AT system board, you must use Option #1 below to configure Switch Block #3. (You must also configure your AT system board; instructions for doing so will be given later in Installation Step 7, as well as in Appendix E of this manual.)
- If you have 512K on your AT system board, you may use either Option #2 or Option #3 to configure Switch Block #3.
- Appendix D lists all possible starting address switch settings for the *Advantage!*.

The starting memory address of the *Advantage!* should be selected from one of the following three options, depending on the configuration of your AT:

- Option #1—Split Memory Addressing in a 256K AT. This *Advantage!* configuration is mandatory in all 256K ATs.

Configuration and Installation

- Option #2—Split Memory Addressing in a 512K AT
- Option #3—Contiguous Memory Addressing in a 512K or 640K AT

If the configuration you want does not fall into one of the above three categories, please refer to Section 4.

Option #1—Split Memory Addressing in a 256K AT: If your AT has 256K on its system board, you must enable Split Memory Addressing on the *Advantage!* using the switch settings in Figure 3-4.

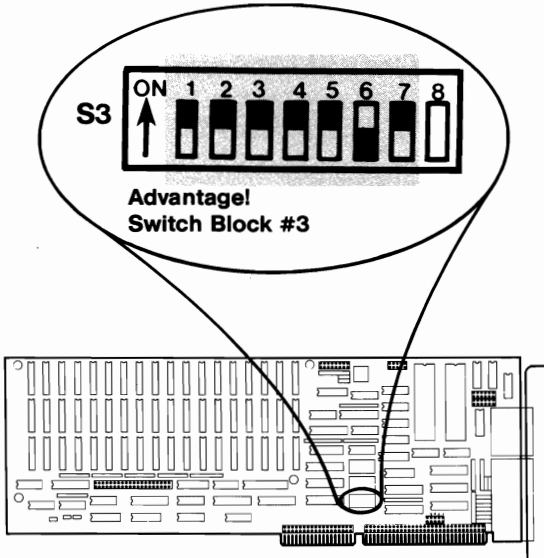

Figure 3-4. Split Memory Addressing in a 256K AT

In this configuration, the first 384K of memory on the *Advantage!* is dedicated to rounding out the AT's base memory area to its 640K maximum.

Please note the following facts regarding *Advantage!* installation in a 256K AT:

- If the *Advantage!* has more than 384K on it, the first 384K is used to round out the AT's base memory to 640K, with the remaining *Advantage!* memory addressed as expansion memory.
- If the *Advantage!* has 384K or less on it, this memory is added to the AT's 256K system board memory, for total base memory of 384K, 512K or 640K. There would be no expansion memory in the 15 MB extended memory area.
- If you are installing the *Advantage!* in a 256K AT, or if you are changing the AT system board memory configuration at this time, you must properly configure your AT system board. Instructions for doing so are given later in Installation Step 7, as well as in Appendix E of this manual.

Option #2—Split Memory Addressing in a 512K AT: If your AT has 512K on its system board, you may use the first 128K of memory on the *Advantage!* to round out the AT's base memory area to its 640K maximum by setting the *Advantage!* switch settings as shown in Figure 3-5.

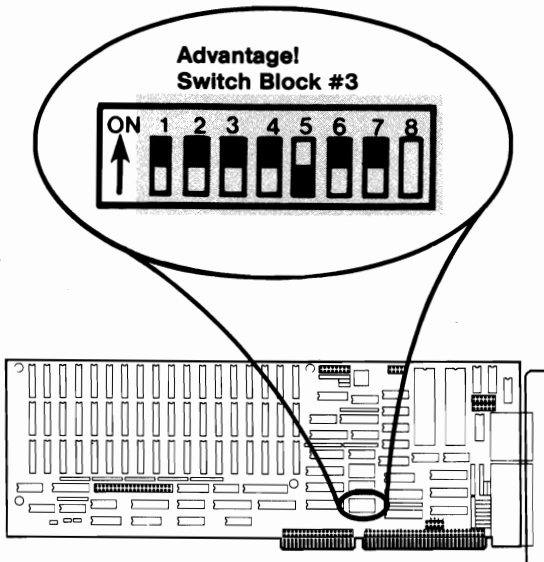

Figure 3-5. Split Memory Addressing in a 512K AT

In this configuration, the first 128K of memory on the *Advantage!* is dedicated to rounding out the AT's base memory area to its 640K maximum.

- If the *Advantage!* has exactly 128K on it, this memory is added to the 512K system board memory, for total base memory of 640K. There would be no expansion memory in the 15 MB extended memory area.
- If the *Advantage!* has more than 128K on it, the first 128K is used to round out net base memory to 640K, with the remaining *Advantage!* memory addressed as expansion memory.

The configuration described in Option #2 may be useful if you are using application software which can access a full 640K of base memory.

Option #3—Contiguous Memory Addressing in a 512K or 640K AT: If your AT has 512K on its system board, you may address all of the *Advantage!* memory as expansion memory in the 15 MB extended memory area. You should also use this configuration if you have the IBM 128K card in your AT.

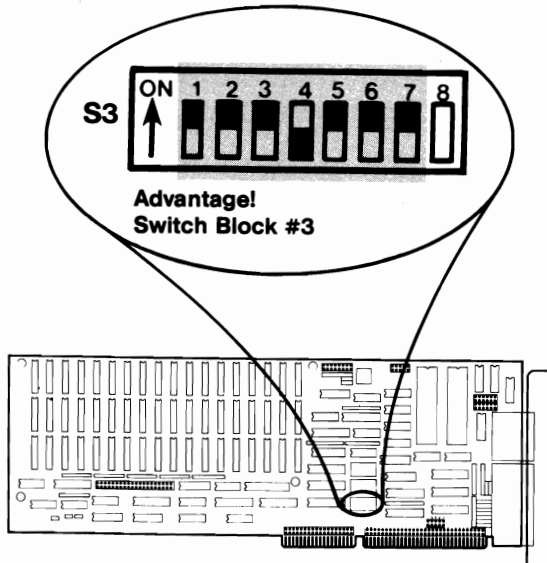

Figure 3-6. Contiguous Memory Addressing in a 512K or 640K AT

In this configuration, all of the memory on the *Advantage!* is used as expansion memory. The 640K base area is not affected by the *Advantage!*.

STEP 3—Selecting Error Checking

The *Advantage!* fully supports the AT's memory error checking feature. This error checking feature is called "Parity Checking". When parity checking is enabled, if a memory error occurs on the *Advantage!*, a parity error will be generated and an error message will appear on the screen. If an error occurs while parity checking is disabled, no message would be generated and you would have no way of knowing there was an error. It is therefore recommended that you leave this switch on so that memory errors will not go undetected. The *Advantage!* is factory configured with parity enabled.

Disabling parity checking on the *Advantage!* does not affect the error-detecting capability of the AT's built-in system board memory.

Switch Block #1, Position 8, on the *Advantage!* enables or disables parity checking. Setting this switch ON enables parity checking, while setting this switch OFF disables parity checking.

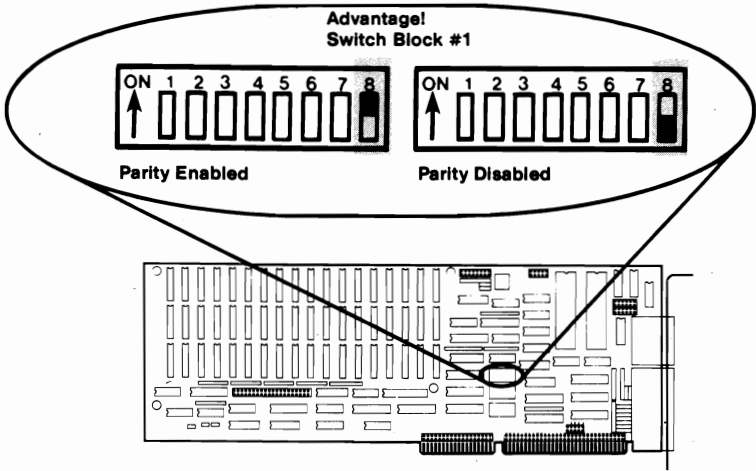

Figure 3-7. Enabling/Disabling Parity

STEP 4—Configuring the Serial Ports

The AT running under single-user PC-DOS will support up to 2 serial ports, called COM1 and COM2. Depending on how many ports your AT already has installed and how many ports your *Advantage!* has, set Switch Block #2 on the *Advantage!* according to either Table 3-1 or Table 3-2.

Table 3-1. Configuration for *Advantage!* with One Serial Port

Number of Serial Ports Already in the AT	Switch Block #2	IRQ Jumpers	Function of <i>Advantage!</i> Serial Ports
0			Serial #1 functions as COM1 Serial #2 disabled
1			Serial #1 functions as COM2 Serial #2 disabled
2			Serial #1 disabled Serial #2 disabled

Table 3-2. Configuration for Advantage! with Two Serial Ports

Number of Serial Ports Already in the AT	Switch Block #2	IRQ Jumpers	Function of Advantage! Serial Ports
0			Serial #1 functions as COM 1 Serial #2 functions as COM2
1			Serial #1 functions as COM 2 Serial #2 disabled
2			Serial #1 disabled Serial #2 disabled

STEP 5—Configuring the Parallel Port

Single-user PC-DOS will support up to 3 parallel printer ports, called LPT1, LPT2, and LPT3. If your AT has a color-type display card without a built-in printer adapter port, use Table 3-3 to configure the *Advantage!*. If your AT has a monochrome-type display card with a built-in printer adapter port, use Table 3-4 to configure the *Advantage!*.

Table 3-3. Parallel Port Configuration in AT with Color-Type Display Card

Number of Parallel Ports Already in the AT	Switch Block #2	IRQ Jumpers	Function of Advantage! Parallel Port
0			LPT1
1			LPT2
2			Disabled
3			Disabled

Table 3-4. Parallel Port Configuration in AT with Monochrome-Type Display Card

Number of Parallel Ports Already in the AT (with Monochrome Card)	Switch Block #2	IRQ Jumpers	Function of Advantage! Parallel Port
1			LPT2
2			LPT3 (No Interrupt)
3			Disabled

STEP 6—Configuring the Game Port

If your *Advantage!* has the optional game port installed, enable the port by turning on the appropriate position of Switch Block #2, as shown in Figure 3-8. If the *Advantage!* game port option was factory installed, this switch should already be on.

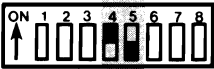
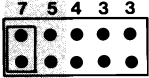
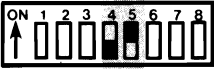
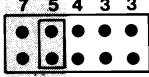
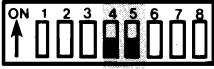
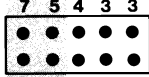
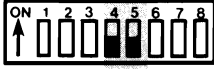
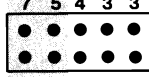
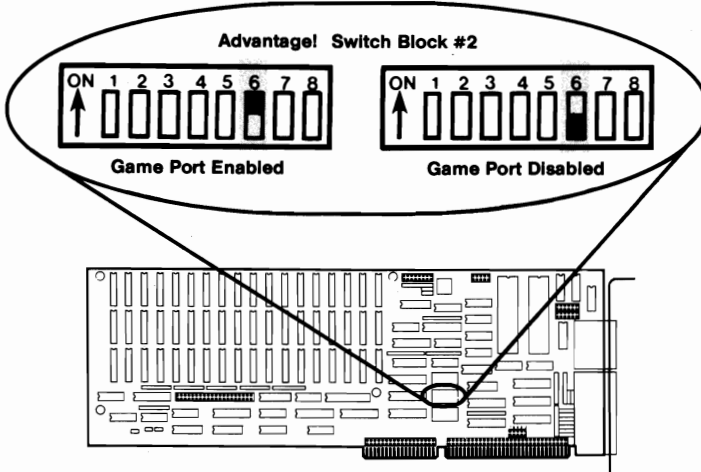

Figure 3-8. Game Port Enable

STEP 7—Installing the *Advantage!* in the AT

You can install the *Advantage!* card in expansion slots 2 through 6 on the AT system board.

CAUTION

Be sure that the power is off and that the power cord is removed from the AT before installing or removing any equipment.

7-A: Remove the AT System Cover

Refer to Section 2 of the IBM AT *Installation and Setup* manual if you need instructions on removing the AT system cover.

7-B: Verify AT System Board Configuration

NOTE: If your AT is equipped with a 512K system board, it is not necessary to perform this step; proceed to Step 7-C.

A jumper on the AT system board (J18) determines the maximum amount of memory the system board will accept. With the jumper in the 256K position, the system board will accept a maximum of 256K; with the jumper in the 512K position, the system board will accept a maximum of 512K.

This jumper *must* be in the correct position to ensure reliable AT operation:

- If you have 256K on your system board and you are installing a memory board like the *Advantage!*, the jumper must be in the 256K position.
- If you have 512K on your system board, the jumper must be in the 512K position.

The jumper is identified on the system board as “J18” and is located underneath the disk controller card at the very front of the AT chassis. Figure 3-9 shows the location of this jumper and its two configuration positions.

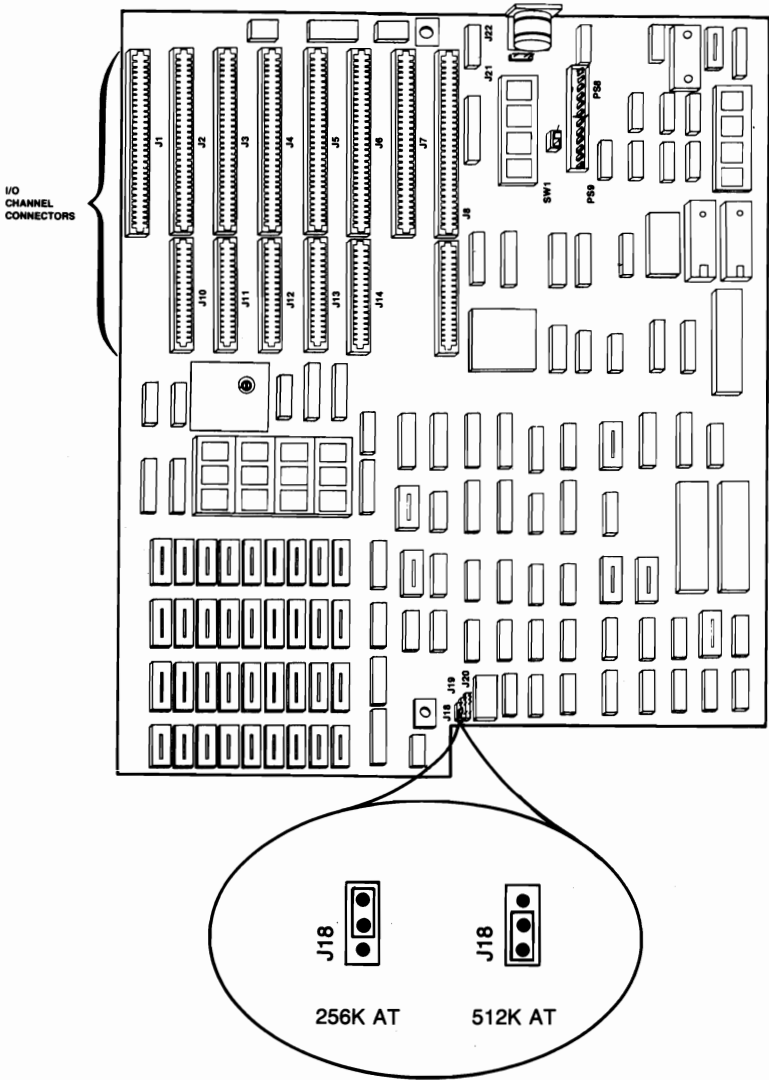

Figure 3-9. AT System Board Memory Configuration Jumper

It may be necessary to lift the disk controller card up in order to gain access to the jumper. To do this, remove the screw securing the disk controller card bracket to the AT chassis and *carefully* lift up the card about 2 inches, being careful not to put excessive stress on the ribbon cables attached to the top of the card.

When you have the jumper correctly configured, re-seat the disk controller card and secure its bracket to the AT chassis with the screw.

7-C: Install the *Advantage!* Ribbon Cables

This step is necessary only if your *Advantage!* has the optional game port or second serial port installed. If not, proceed with Step 7-D. Figure 3-10 shows the locations of these two ports on the *Advantage!* board.

Locate the ribbon cable(s) for the serial port and/or the game adapter port. The serial port ribbon cable has a rectangular 10-conductor connector at one end and a male (plug) DB9 connector at the other end. The game adapter port ribbon cable has a rectangular 16-conductor connector at one end and a female (socket) DB15 connector at the other end.

Each ribbon cable comes with a bracket. Using the hardware supplied on the D connectors, mount the D connectors to the brackets so that when the brackets are installed, the D connectors will be accessible at the AT's rear panel.

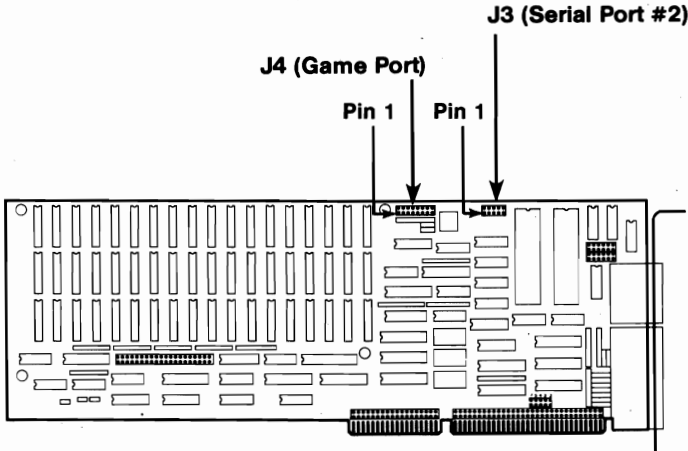

Figure 3-10. Serial Port #2 and Game Port Connector Locations

Serial Port: Plug the serial adapter cable onto connector J3 on the *Advantage!*. Plug the cable onto the board so that Pin 1 on the rectangular connector (indicated by an arrow and the red or blue stripe on the ribbon cable) aligns with Pin 1 on the J3 connector, which is silkscreened in white on the circuit board.

Game Port: Plug the game adapter cable onto connector J4 on the *Advantage!*. Plug the cable onto the board so that Pin 1 on the rectangular connector (indicated by an arrow and the red or blue stripe on the ribbon cable) aligns with Pin 1 on the J4 connector, which is silkscreened in white on the circuit board.

7-D: Select an Open Expansion Slot

Expansion slot 2, 3, 4, 5, or 6 may be used for the *Advantage!* (the slot numbers are visible at the back panel of the AT).

You will need one or two additional slots if you are installing the optional serial and game port cables in the supplied brackets.

Locate the metal bracket that covers the cut-out in the back panel of the AT chassis for the slot that you have selected. Remove and save the bracket-retaining screw using a small flathead screwdriver. Remove the bracket. Do the same for the additional slots used for installing the option port cables if necessary.

7-E: Install the *Advantage!* Board

Line up your *Advantage!* card in the selected slot and position its front bottom corner in the plastic card guide channel at the front of the AT chassis. Keeping the top of the *Advantage!* card level and any ribbon cables out of the way, lower the card until its gold edge connectors are aligned with the system board expansion slot connectors. Using an evenly distributed pressure, press the *Advantage!* straight down until it seats in the expansion slot.

Secure the *Advantage!* board to the AT chassis using the bracket retaining screw removed previously.

7-F: Install the Option Cable Brackets

If you are using the supplied brackets to mount your option port cables, install these brackets into the slot cutouts you have chosen. Route the cables so they will not be in the way when you replace the cover.

7-G: Reinstall the AT System Unit Cover

Refer to Section 4 of the IBM AT *Installation and Setup* manual for instructions on reinstalling the cover. Use caution when replacing the cover so that you do not snag any of the ribbon cables on the *Advantage!* or any other internal AT cables.

STEP 8—Run the AT SETUP and Diagnostic Program

Any time you change the system configuration of your AT by adding or removing memory or I/O ports, you must run the SETUP program. Instructions for running SETUP are contained below.

8-A: Diagnostic Program Boot Up

Boot the AT with the IBM "Diagnostics for IBM Personal Computer AT" diskette. This diskette is found at the back of the *Guide to Operations* manual for the AT.

8-B: Run SETUP

Select Option 4, "SETUP." Answer the questions as appropriate for the new amount of system memory and expansion memory in your AT.

Some notes about the SETUP program:

- SETUP will ask you a number of questions about your AT configuration that are unrelated to the *Advantage!* installation (for example, it verifies the type of floppy drive, monitor type, time and date, etc.). There is no need to change any of these parameters unless one is in error. SETUP will ask you to verify correct memory configuration following these other questions.
- In order to change the amount of expansion (extended) memory you must first tell SETUP that you want to change the amount of base memory; re-enter the correct amount of base memory, then enter the new amount of expansion memory.
- Appendix D contains two tables which may be helpful in computing the amount of expansion memory in your AT in Kilobytes (SETUP wants all information in Kilobytes):

Table D-1 can be used to compute the amount of base and expansion memory (as well as the net total memory) in either a 256K or 512K AT, for all possible *Advantage!* configurations.

Table D-2, which gives all the possible switch settings for Switch Block #3, can also be used to convert memory size values between Megabytes and Kilobytes.

- When entering the amount of base memory, 256, 384, 512, and 640 are all valid configurations (the screen display implies that 384K is not permitted).
- When entering the amount of expansion memory, you can use any 128K value, beginning at zero (0, 128, 256, 384, etc.) up to a maximum of 15360 (15 Megabytes).
- Note once again that if you have 256K on your AT system board, the *Advantage!* should be configured for Split Memory Addressing. Unless you have more than 256K of base memory (either by filling the system board with chips or by using Split Memory Addressing on the *Advantage!*), SETUP will not recognize any expansion memory.

After the system completes the Setup procedure, it will reboot and reenter the diagnostics.

8-C: Test the New Configuration

Referring to Section 2 of the IBM *Guide to Operations* manual for instructions, run the system diagnostics to test your new configuration.

This completes the installation of the *Advantage!*.

(This page intentionally left blank)

SECTION 4

MEMORY CONFIGURATION

The advanced memory design characteristics of the *Advantage!* give it outstanding flexibility. Besides being able to add up to 3 Megabytes to your AT, you can usually install the *Advantage!* alongside other AT-compatible memory cards (including other *Advantage!* cards) to increase memory capacity beyond 3 Megabytes. The *Advantage!* also has a unique feature called *Split Memory Addressing*. This allows the *Advantage!* to round out the AT's base memory to its 640K maximum, while also giving you additional memory in the AT's 15 Megabyte expansion memory area.

This section describes the AT's memory addressing capabilities and how the *Advantage!* can be utilized to make the most of these features. Also discussed are how to expand the *Advantage!* memory yourself, and how to use the *Advantage!* along with other memory cards in your AT.

4.1 AT Memory Addressing

Figure 4-1 illustrates a simplified system memory map for the AT:

Memory Configuration

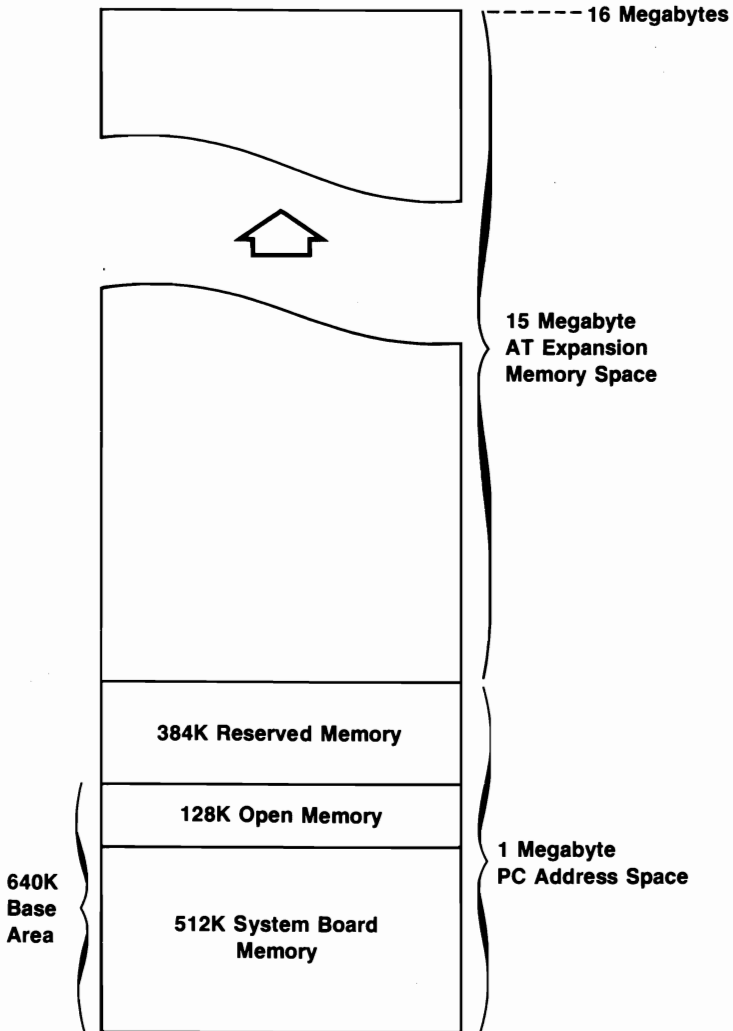

Figure 4-1. AT System Memory Map

If you are familiar with the standard IBM PC memory map, you will note that the first Megabyte of the AT is organized the same as the PC: 640K user memory, followed by 384K reserved for internal use by the computer. This adds up to 1 Megabyte of memory, the maximum a regular PC can use.

The AT, on the other hand, has the capability of using memory above the 1 Megabyte limit of the PC, up to a total of 16 Megabytes. This additional 15 Megabyte space in the AT is called *Expansion Memory*, while the 640K space is called *Base Memory*.

4.1.1 The 640K Base Memory Area—Split Memory Addressing

The AT system board comes populated with either 256K or 512K of memory. In either case, the AT is short of its maximum 640K base memory. When your AT has 512K, a separate 128K card can be used to bring the AT's base memory up to its maximum of 640K. However, this has the disadvantage of using up an extra slot. Any additional expansion memory cards would of course require further slots.

The *Advantage!*, on the other hand, can be used to round out the base memory to a full 640K, while also providing expansion memory. This feature is called *Split Memory Addressing*.

If your AT has 256K on its system board, you *must* use the Split Memory Addressing feature on the *Advantage!*. In this case, the *Advantage!* contributes up to 384K to the 640K base memory, depending on how much memory is available on the *Advantage!*. If you have other than 256K or 512K in your AT base memory (e.g., 384K), the *Advantage!* must be used as expansion memory only.

Memory Configuration

If your AT has 512K on its system board, you have two options for configuring the *Advantage!*: Split Memory Addressing allows it to round out the AT's 640K base memory. Or you can use all the *Advantage!* memory as expansion memory. Operating the *Advantage!* in the Split mode will cause it to contribute 128K to the AT's 640K base memory.

For example, if you have a 512K AT and a 1.5 MB *Advantage!*, and you want to use Split Memory Addressing to round out the base memory of the AT to 640K, this would result in 640K base memory and 1.375 MB (1.5 MB minus 128K) of expansion memory. This configuration is illustrated in Figure 4-2.

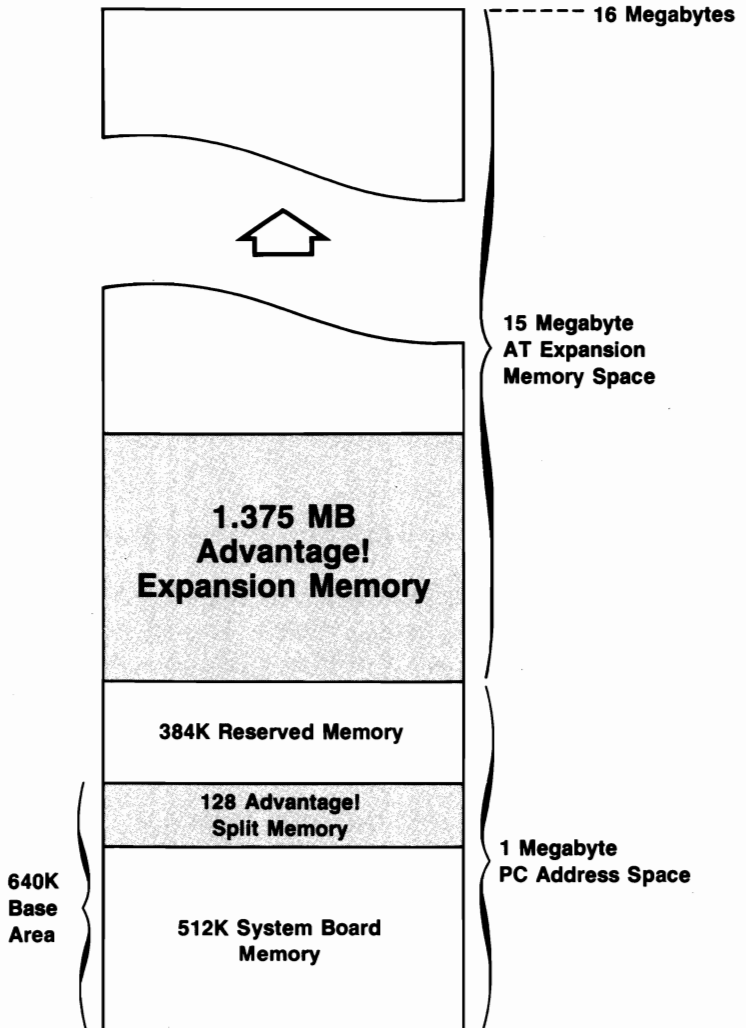

Figure 4-2. Split Memory Addressing

Memory Configuration

Of course, if you already have another 128K memory card, the *Advantage!* can still be used; all of its memory will be located in the AT's 15 MB expansion memory area.

The Split Memory Addressing feature of the *Advantage!* is enabled or disabled when you set the card's starting address with Switch Block #3. This topic is discussed in detail in Subsection 4.2.

Note that you can use Split Memory Addressing even if you have insufficient memory on the *Advantage!* to round out the AT's base area to a full 640K. In this case, whatever is available on the *Advantage!* is added to the existing AT system board memory, and there will be no expansion memory on the *Advantage!*. (Later, as your memory needs grow, you can add more memory chips to the *Advantage!* to both round out the 640K base memory as well as to provide expansion memory.)

4.1.2 The 15 Megabyte Expansion Memory Area

Beginning at the 1 Megabyte address, there are 15 Megabytes of expansion memory space in the AT. This space can be used for RAM disks such as IBM's VDISK.SYS utility, or for multiuser operating systems such as XENIX. Application software designed especially for the AT will also be able to utilize this memory. Figure 4-1 illustrates this 15 Megabyte area.

Memory installed in the 15 Megabyte expansion memory area must be contiguous, and must start at the 1 Megabyte address boundary. No gaps are allowed.

4.1.3 AT System Board Memory Configuration

The AT system board may be configured with either 256K or 512K. A jumper on the system board determines whether the maximum system board memory is 256K or 512K. Whenever

you add or remove chips on the system board, or when you install an *Advantage!* card, you should verify correct configuration of this jumper. Appendix E contains the necessary instructions for configuring this jumper.

4.2 Setting the Starting Memory Address of the *Advantage!*

The starting memory address of the *Advantage!* must be set so that it fits into the AT system memory map without conflicting with other memory. The *Advantage!* (along with any other memory cards) must also fit into the memory map in such a way that there are no gaps.

Switch Block #3 on the *Advantage!* is used to set its starting address. If you are using no other memory cards or if you have only the IBM 128K card, the instructions in Topic 3.1, Step 2, will tell you exactly how to set Switch Block #3 on the *Advantage!*.

Appendix D illustrates all the possible combinations of settings for Switch Block #3 on the *Advantage!*.

4.3 If You Have Other Memory Cards

The *Advantage!* can usually be installed along with other AT memory cards, including IBM's, without causing any problems. However, you must be careful to set the starting addresses for each card so they do not conflict with each other.

NOTE

If the only other memory card in your AT is the IBM 128K board, use the recommended settings in Topic 3.1, Step 2, for Switch Block #3 on the *Advantage!*.

4.3.1 Installing a Card “Below” the *Advantage!*

To address another memory card “below” the *Advantage!*, follow this procedure:

STEP 1

Using the instructions supplied with the other card, configure the other card so its starting address is at 1 Megabyte. If you are using more than one card below the *Advantage!*, ensure that they do not conflict with each other and that they occupy contiguous memory starting at 1 Megabyte.

STEP 2

If necessary, disable any unused memory sockets on the other cards so they won't conflict with each other or with the *Advantage!*. If you cannot disable unused sockets on a card, the other card should be addressed “above” the *Advantage!* (refer to Topic 4.3.2). If the other card has switch settings for the amount of memory on it, then it will probably automatically disable any unused memory sockets.

STEP 3

Set the *Advantage!* starting address to :

1 Megabyte plus the size of the other card(s)

For example, if the other card has 512K of memory, set the *Advantage!* starting address to 1.5 Megabytes, which is hexadecimal address :180000 (refer to Appendix D).

STEP 4

Install the cards and run the AT's SETUP program to tell it the new amounts of (1) base memory and (2) expansion memory. You can use the tables in Appendix D to convert Megabytes to Kilobytes (SETUP requires information in Kilobytes).

4.3.2 Installing a Card "Above" the *Advantage!*

To address another card "above" the *Advantage!*, follow this procedure:

STEP 1

Set the *Advantage!* starting address to one of the first three entries in the tables in Appendix D. Use the first entry if your AT has 256K on the system board. Use the second entry if your AT has 512K on the system board and you want to use Split Memory Addressing. Use the third entry if you do not want Split Memory Addressing or if you have the IBM 128K board.

STEP 2

Referring to the instructions supplied with the other card, set the other card's starting address to:

1 Megabyte plus the amount of *expansion* memory on the *Advantage!*

For example, if the *Advantage!* has 1.5 Megabytes of expansion memory on it, you would set the other card's starting address at 2.5 Megabytes, which is hexadecimal address :280000.

If you are using Split Memory Addressing on the *Advantage!*, remember that the amount of expansion memory is the total *Advantage!* memory minus the amount it contributes to the 640K user memory area. Using the above example, a 1.5 Megabyte *Advantage!* with Split Memory Addressing enabled in a 512K AT would have 1.375 Megabytes of expansion memory (1.5 MB minus 128K), so you would set the other card's starting address at 2.375 Megabytes (1 MB + 1.375 MB), which is hexadecimal address :260000.

STEP 3

Run the AT's SETUP program and configure it for the new amounts of (1) base memory and (2) expansion memory. You can use the tables in Appendix D to convert Megabytes to Kilobytes (SETUP requires information in Kilobytes).

4.4 Installing Additional Memory on the Advantage!

On the *Advantage!* and Advantage-Pak, a memory row which is populated with 18 64K memory chips contains 128K bytes of memory, while a row populated with 18 256K memory chips contains 512K bytes of memory:

- (18) 64K Chips = 128K Bytes (64K 16-Bit Words)
- (18) 256K Chips = 512K Bytes (256K 16-Bit Words)

An *Advantage!* or Advantage-Pak which is not fully populated can be upgraded with additional memory simply by plugging in additional memory chips. You can also upgrade from 64K chips to 256K chips. AST offers 128K memory upgrade kits for the *Advantage!* and Advantage-Pak, consisting of 18 64K chips; order AST part number MPAD-128. AST also offers 512K memory upgrade kits consisting of 18 256K chips; order AST part number MPAD-512.

4.4.1 Memory Chip Specifications

If you purchase memory chips from another source, be sure they meet the following specifications.

64K Chip Specifications. Use 64K Dynamic Random Access Memory (DRAM) with these characteristics:

- 150 nanosecond (ns) access time
- Pin 1 not used
- +5 Volt Only

6 MHz ATs

FOR 8 MHz ATs,
USE 120 ns chips
(see addendum)

The following 64K memory chips are compatible.

- Micron Technology MT4264-2 or MT4264-15
- Hitachi HM4864-2
- NEC D4164-15
- Motorola MCM6665AP-15 or MCM6665APAL-15
- Fujitsu MB8264-15
- Texas Instruments TMS4164-15

256K Chip Specifications. Use 256K Dynamic Random Access Memory (DRAM) with 150 nanosecond (ns) access time. The following manufacturer's 256K (150 ns) memory chips are compatible:

- AT & T WCM41256FX-15
- Fujitsu MB81256-15
- Hitachi HM50256P-15
- Mitsubishi M5M4256P
- Motorola MCM6256L
- Texas Instruments TMS4256-15NL
- Toshiba TMM41256P-15

6 MHz ATs
ONLY
(see addendum)

4.4.2 Populating the Memory Rows with Memory Chips

Figure 4-3 illustrates the arrangement of the rows of memory chips on the *Advantage!*.

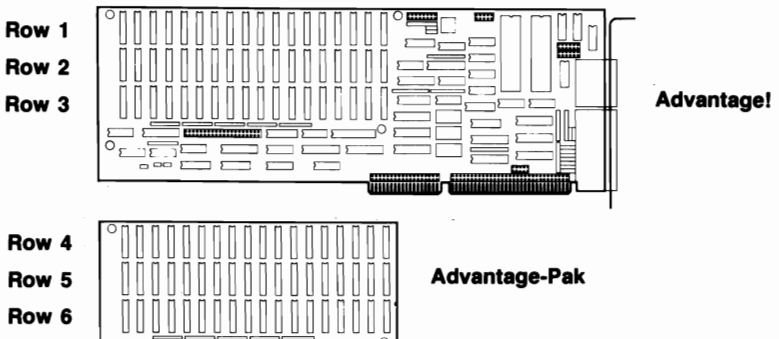

Figure 4-3. Memory Row Configuration

Memory Configuration

The *Advantage!* main board can have up to three rows of memory on it, numbered 1, 2, and 3. The optional Advantage-Pak piggyback memory card provides additional rows of memory, numbered 4, 5, and 6. This provides up to 3 Megabytes in the space of a single AT expansion slot.

When adding memory to the *Advantage!* or Advantage-Pak, please note the following:

- The memory rows on the *Advantage!* and Advantage-Pak must be populated in sequential order. You cannot have an empty row of sockets in between two populated rows.
- Do not install the Advantage-Pak piggyback board unless all three rows on the *Advantage!* main board are fully populated.
- Whenever you add or remove memory on the *Advantage!*, be sure you re-adjust Switch Block #1 to reflect the new memory configuration on the card. This topic is discussed in Subsection 4.5.
- You must run the AT's SETUP program any time you add or remove memory from the AT.

4.4.3 Mixing 64K and 256K Memory Chips

When mixing 64K and 256K chips on the same board, please note the following:

- Each row of 18 chips must be populated entirely, using one type of chip. You cannot intermix 64K and 256K chips in the same row.
- Once a row of 256K chips is installed, all the following rows must use only 256K chips. For example, if you have 64K chips in Rows 1 and 2, and you install 256K chips in Row 3, then Rows 4 thru 6 (on the Advantage-Pak) must all use 256K chips.

4.5 Setting the Memory Size of the *Advantage!*

Switch Block #1 on the *Advantage!* tells the card how much memory is installed on it. The diagram in Figure 4-4 shows you the location and settings of Switch Block #1, as well as the location of the memory rows on the *Advantage!*.

Memory Configuration

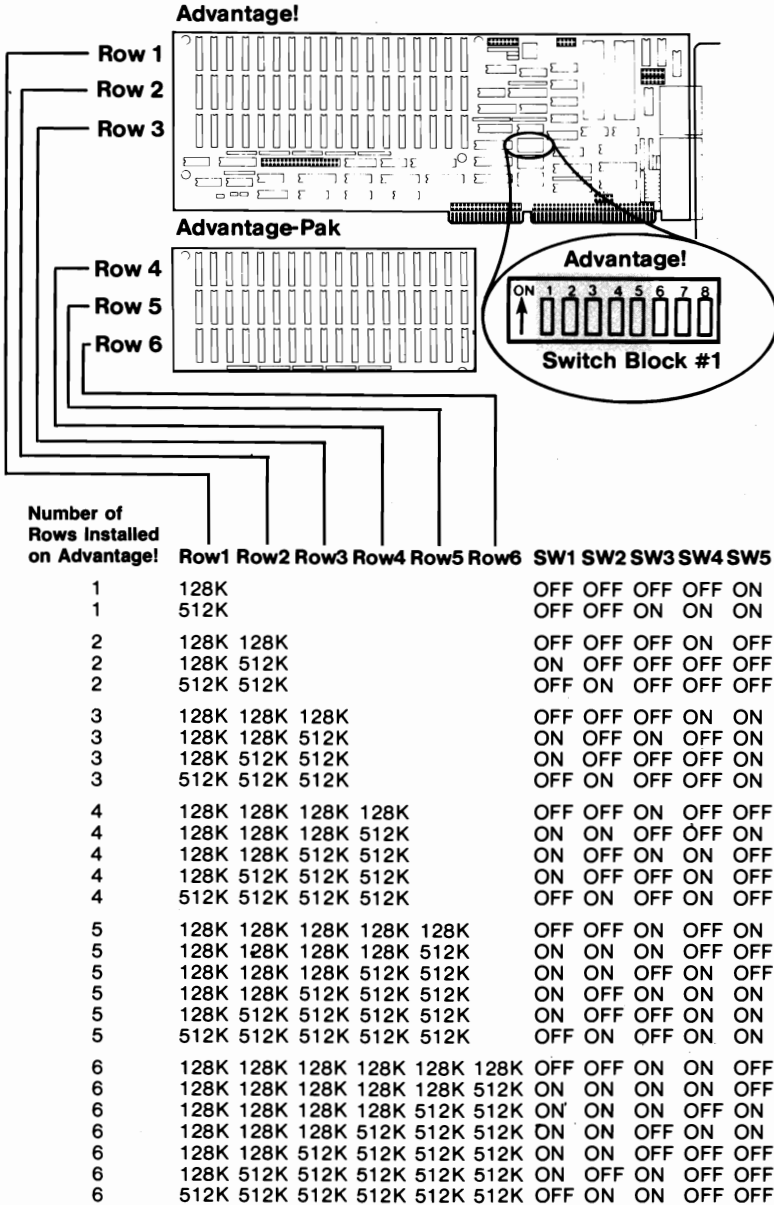

Figure 4-4. Switch Block #1 and Memory Rows

Figure 4-4 shows the settings for Switch Block #1 on the Advantage!. This switch tells the card how much memory it has and how the memory chips are configured.

The switch settings in Figure 4-4 are separated into six groups according to the number of memory rows installed on the Advantage!; 1 row of memory, 2 rows of memory, etc. Within each group, the settings are then broken down according to the number of rows populated with 128K (using 64K chips), and the number of rows populated with 512K (using 256K chips).

Examples of typical memory size switch configurations are shown in Figures 4-5 and 4-6.

Example 1: If your Advantage! has one row of memory consisting of 128K, you would use the first entry in the table, and set Switch Block #1 as shown in Figure 4-5.

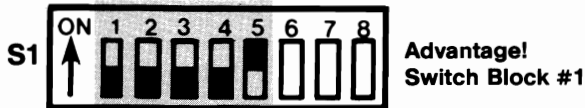

Figure 4-5. Memory Size Example #1

Memory Configuration

Example 2: If your *Advantage!* has four rows of memory (including the Advantage-Pak piggyback board), and the first row has 128K while rows 2, 3, and 4 have 512K, you would set Switch Block #1 as shown in Figure 4-6.

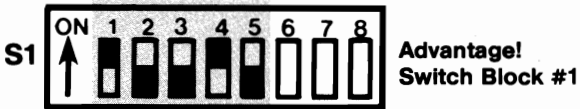

Figure 4-6. Memory Size Example #2

Set the switches to match the amount of memory on your *Advantage!*.

SECTION 5

SERIAL PORTS

The serial ports in the AT provide an asynchronous (async) serial communications link between the computer and serial peripheral devices such as modems, serial printers, plotters, a mouse, or other peripherals which use a serial interface. Data communication between the computer and the external device is handled "serially", one bit at a time. There are nine interface lines available for serial communications between the computer and the external device: one is used by the computer to send data, while a second is used by the computer to receive data. The remaining interface lines may be used as "handshaking" flags to control the flow of data back and forth.

An AT running under single-user PC-DOS will support up to two serial ports. These ports are referred to as COM1 and COM2 (some IBM manuals also refer to them as Async and Alternate Async, respectively). COM1 and COM2 are the only two serial ports which single-user PC-DOS can access.

The *Advantage!* can be equipped with either one or two asynchronous serial communication ports. Serial Port #1 is standard, and can be configured as either COM1 or COM2. Serial Port #2 is optional, and can be configured as COM2 only. Either or both ports can be disabled if necessary to avoid conflicts with other AT serial ports you may already have. The *Advantage!* serial ports conform to the RS-232C communications standard.

5.1 Technical Information About AT Serial Ports

The following technical information applies to the the serial ports on the *Advantage!*.

5.1.1 I/O Address and Interrupt Assignments

The serial ports supported by single-user PC-DOS in the AT are assigned the following hardware I/O addresses and interrupt request (IRQ) lines as described in Table 5-1.

Table 5-1. AT Serial Port I/O Address & IRQ Assignments

Port	I/O Address	IRQ Line Used
COM1	3F8-3FF Hex	IRQ4
COM2	2F8-2FF Hex	IRQ3

The *Advantage!* conforms to this standard and uses identical I/O and IRQ assignments.

5.1.2 Serial Port Pinout Specifications

The serial ports in the AT and on the *Advantage!* use a DB9P (plug or male) interface connector with a DTE (Data Terminal Equipment) interface configuration. The pinout for both ports is identical at the DB9 connectors and is shown in Table 5-2.

Table 5-2. DB9 Serial Port Pinouts

RS-232C Name	Cable Pin #	Signal Name	Signal Direction
AA	1	(Chassis Ground)	Common
BA	2	TxD (Transmit Data)	Output
BB	3	RxD (Receive Data)	Input
CA	4	RTS (Request to Send)	Output
CB	5	CTS (Clear to Send)	Input
CC	6	DSR (Data Set Ready)	Input
AB	7	SG (Signal Ground)	Common
CF	8	DCD (Data Carrier Detect)	Input
CD	20	DTR (Data Terminal Ready)	Output
CE	22	RI (Ring Indicator)	Input

Most serial peripheral devices use DB25 connectors. Therefore, you will probably need to use a DB9-to-DB25 adapter cable between the AT serial port and the external device. AST offers a cable for this purpose, Model Number ADV-AC. This cable is 6 feet in length and serves the purpose of remapping the DB9 serial pinouts into the standard DB25 configuration as shown in Figure 5-1. (IBM also offers a similar cable.)

DB9 Connector (AT)		DB25 Connector
1	Carrier Detect DCD	8
2	Receive Data RxD	3
3	Transmit Data TxD	2
4	Data Terminal Ready DTR	20
5	Signal Ground GND	7
6	Data Set Ready DSR	6
7	Request to Send RTS	4
8	Clear to Send CTS	5
9	Ring Indicator RI	22

Figure 5-1. DB9 to DB25 Serial Port Conversion Pinouts

Figure 5-2 illustrates a typical application using the DB9-to-DB25 adapter cable.

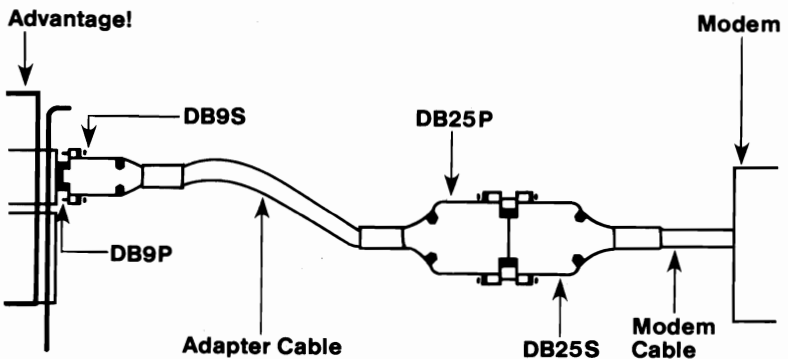

Figure 5-2. Serial Port Interface Using the DB9-to-DB25 Adapter Cable

Since most serial devices use the DB25 configuration, the information in Appendix A and Appendix B is presented in that format. That is, an assumption is made that you will be using a DB9-to-DB25 adapter cable between the AT and the serial device. If this is not the case, substitute the DB9 pin numbers shown in Figure 5-1 for the DB25 pin numbers used in Appendix A and Appendix B.

5.1.3 Managing the *Advantage!* Serial Port Inputs

Because of the way PC-DOS manipulates the serial ports, all of the input signals on the interface (with the exception of pin 9, Ring Indicator) must be driven by the external device. If one or more of the inputs is left disconnected or not driven, PC-DOS may interpret this as meaning that the peripheral device is not ready and will refuse to communicate with it. One way to deal with this problem in the AT is to build special interface cables which shuffle the signals around so that PC-DOS thinks the external device is ready. Some of the the wiring examples used in Appendix A use this technique.

As an alternative, the *Advantage!* board provides a simple method for insuring that all the serial port inputs are driven. Shorting plugs (jumpers) on the *Advantage!* can be configured to force one or more of the serial port inputs into a constant "true" state. This will cause PC-DOS to think that the external device is ready and allow data transfer to occur. This is done by configuring shorting plugs on the RS-232C Configuration Block as shown in Figure 5-3.

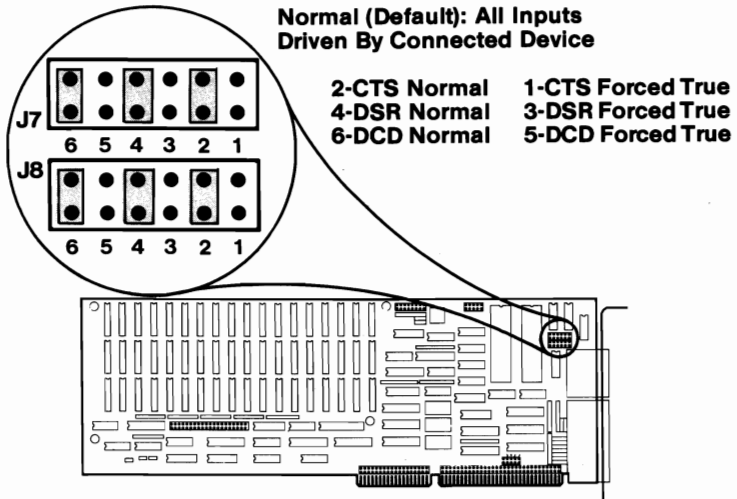

Figure 5-3. Serial Port Input Line Configuration Block

As you can see from Figure 5-3, J7 controls the inputs to Serial Port #1, while J8 controls the inputs to Serial Port #2. For each port, you can manipulate (force true) the CTS, DSR, or DCD inputs, in any combination.

Figure 5-3 shows the shorting plugs in their factory default configuration; in this configuration, the input lines are left undisturbed as they enter the card. That is, the external device is expected to drive all these inputs. To force an input line true, move the appropriate shorting plug from the "Normal" position to the "Forced True" position. For example, to force the DSR input on Serial Port #2 into a constant "true" state, you would move the shorting plug from J8 pin 4 to J8 pin 3. Whenever a signal is forced true in this manner, the actual state of its corresponding input on the DB9 serial port connector will be ignored.

If you use the wiring diagrams in Appendix A to interface a serial printer, the shorting plugs shown in Figure 5-3 should all be left in the "Normal" configuration.

5.1.4 Configuring External Serial Devices

Whenever you connect a new device to your computer such as a serial printer, you will also have to perform a one-time configuration of that device to establish the correct baud rate, number of data bits, etc. This usually involves setting switches on the device. Refer to the installation manual supplied with the device for further information on its configuration requirements. Be sure the serial port parameters used by your application programs (as well as PC-DOS "MODE" and "OPEN" commands) match the configuration of your serial device.

If you change devices during a computing session (for example, if you unplug a serial printer and connect a modem), you may have to enter a new "MODE" or "OPEN" command to establish different communication parameters to match the new device. However, if your application software is controlling the ports, this will probably not be necessary.

More information about programming the serial ports is contained in Section 5.1.5.

5.1.5 Programming the Serial Ports

At the start of each computing session, before a serial port can be used it must be initialized for the proper baud rate, parity, data bits, and stop bits. If you are running an application program which uses the serial ports, the program will probably initialize the ports automatically. You can also use the DOS "MODE" command or the BASIC/BASICA "OPEN" command to initialize a serial port. Consult the IBM DOS and BASIC manuals for information on these commands.

The *Advantage!* serial ports are completely compatible with all AT software operating parameters.

5.1.6 The AT Serial Port Controller

The serial controller chip used by the AT (and the *Advantage!*) is not 100% compatible with the controller used in the PC/XT line of computers. Therefore, software written for the PC which uses the serial ports may not function properly in the AT.

5.2 *Advantage!* Serial Port Configuration

Positions 1, 2, and 3 of Switch Block #2 on the *Advantage!* card control the configuration of the *Advantage!* serial ports. Shorting plugs on the IRQ Enable Block are used to select the appropriate interrupt (IRQ) line for each port. The location of Switch Block #2 and the IRQ Enable Block are shown in Figure 5-4.

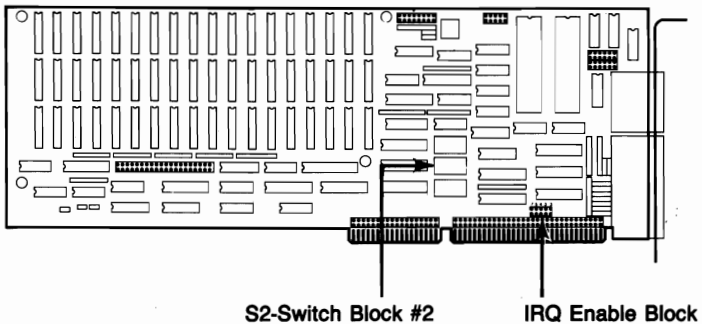

Figure 5-4. Switch Block #2 and IRQ Enable Block Location

All the possible *Advantage!* serial port configurations are shown in Tables 5-3 and 5-4 below. Use Table 5-3 for an *Advantage!* with one serial port, or use Table 5-4 for an *Advantage!* with two serial ports.

Table 5-3. Configuration for Advantage! with One Serial Port

Number of Serial Ports Already in the AT	Switch Block #2	IRQ Jumpers	Function of Advantage! Serial Ports
0			Serial #1 functions as COM1 Serial #2 disabled
1			Serial #1 functions as COM2 Serial #2 disabled
1			Serial #1 disabled Serial #2 functions as COM2
2			Serial #1 disabled Serial #2 disabled

Table 5-4. Configuration for Advantage! with Two Serial Ports

Number of Serial Ports Already in the AT	Switch Block #2	IRQ Jumpers	Function of Advantage! Serial Ports
0			Serial #1 functions as COM 1 Serial #2 functions as COM2
1			Serial #1 functions as COM 2 Serial #2 disabled
1			Serial #1 disabled Serial #2 functions as COM2
2			Serial #1 disabled Serial #2 disabled

5.3 Advantage! Factory Default Serial Port Configurations

The factory-set default configuration of the *Advantage!* serial ports is shown in Figures 5-5 and 5-6 below. Figure 5-5 is for an *Advantage!* with one serial port, while Figure 5-6 is for an *Advantage!* with two serial ports.

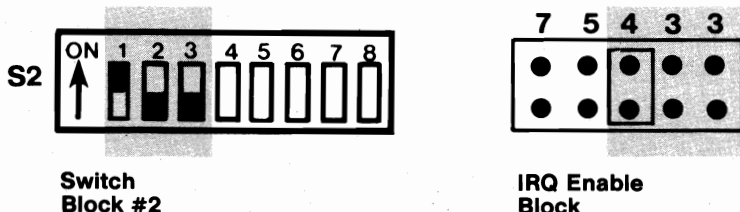

Figure 5-5. Default Settings with One Serial Port

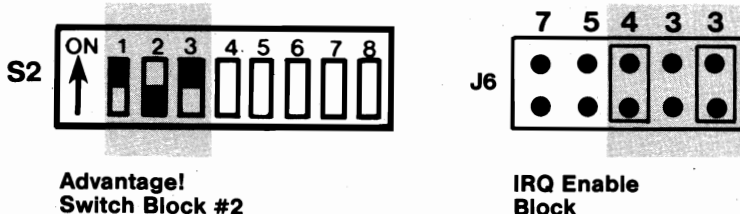

Figure 5-6. Default Settings with Two Serial Ports

5.4 Installing Advantage! Serial Port #2

An upgrade kit is offered by AST for field installation of the second *Advantage!* serial port. This upgrade kit, AST Model Number ADV-000S, contains the special components necessary for proper function of the serial port in an AT. It is available through your AST Dealer. Instructions for installing the optional Serial Port #2 are supplied with the upgrade kit.

(This page intentionally left blank)

SECTION 6

PARALLEL PRINTER PORT

The parallel ports in the AT provide one-way communication (output only) between the AT and parallel peripheral devices such as printers, plotters, or a mouse. Data is sent from the AT to the external device eight bits (one byte) at a time. The flow of data is controlled by several "handshaking" lines on the interface.

An AT running under single-user PC-DOS will support up to three parallel ports. These ports are referred to as LPT1, LPT2, and LPT3 (some IBM manuals also refer to the default port as PRN). These are the only parallel ports single-user PC-DOS can access.

The *Advantage!* is equipped with one parallel port as a standard feature. When the AT is equipped with a monochrome-type display card with built-in printer adapter, the *Advantage!* parallel port can be configured as LPT2 or LPT3. When the AT is equipped with a color-type display card without a built-in printer adapter, the *Advantage!* parallel port can be configured as LPT1 or LPT2.

6.1 Technical Information About AT Parallel Ports

The following technical information applies to the parallel ports in the AT, including the *Advantage!*.

6.1.1 I/O Address and Interrupt Assignments

The parallel ports supported by single-user PC-DOS in the AT are assigned the hardware I/O address and interrupt request (IRQ) lines as described below. Table 6-1 is for an AT which is using a monochrome-type display card with a built-in printer adapter port. Table 6-2 is for an AT using a color-type display card without a built-in printer adapter port.

**Table 6-1. AT Parallel Port I/O & IRQ Assignments
(with Monochrome-Type Display Card)**

Port	I/O Address	IRQ Line Used	Port Location
LPT1	3BC-3BE Hex	IRQ7	Monochrome Card
LPT2	378-37A Hex	IRQ5	Add-on Card
LPT3	278-27A Hex	Not Supported*	Add-on Card

*Interrupt-driven I/O for LPT3 is not supported in the AT.

**Table 6-2. AT Parallel Port I/O & IRQ Assignments
(with Color-Type Display Card)**

Port	I/O Address	IRQ Line Used	Port Location
LPT1	378-37A Hex	IRQ7	Add-on Card
LPT2	278-27A Hex	IRQ5	Add-on Card
LPT3	→ LPT3 Not Supported When Using Color Card ←		

The *Advantage!* conforms to these standards and uses identical I/O and IRQ assignments.

6.1.2 Parallel Port Pinout Specifications

The parallel ports in the AT and on the *Advantage!* use a DB25S (socket or female) interface connector. The pinout for all the parallel ports is identical and is shown in Table 6-3.

Table 6-3. DB25 Parallel Port Pinouts

LINE NAME	AST ADAPTER CABLE OUTPUT DB25S	IBM MATRIX PRINTER CENTRONICS INTERFACE
-STROBE	1	1
D0	2	2
D1	3	3
D2	4	4
D3	5	5
D4	6	6
D5	7	7
D6	8	8
D7	9	9
-ACK	10	10
BUSY	11	11
PE	12	12
SLCT	13	13
-AUTOFD	14	14
-ERROR	15	32
-INIT	16	31
-SLCT IN	17	36
GROUND	(18-25)	(16,19-30,33)

6.1.3 Configuring External Parallel Devices

Whenever you connect a new device to your computer such as a parallel printer, you may also have to perform a one-time configuration of that device to establish desired operating parameters. This is usually done by setting switches in the device. Refer to the installation manual supplied with the device for further information on its configuration requirements.

6.1.4 Programming the Parallel Ports

Normally no special action is necessary to prepare the parallel ports for use. However, you can use the PC-DOS "MODE" command to establish certain parameters such as line width. Consult the IBM DOS manual for information on this command.

The *Advantage!* parallel port is completely compatible with all AT software operating parameters.

6.2 *Advantage!* Parallel Port Configuration

Positions 4 and 5 of Switch Block #2 on the *Advantage!* card control the configuration of the *Advantage!* parallel port. Shorting plugs on the IRQ Enable Block are used to select the appropriate interrupt (IRQ) line for the port. The location of Switch Block #2 and the IRQ Enable Block are shown in Figure 6-1.

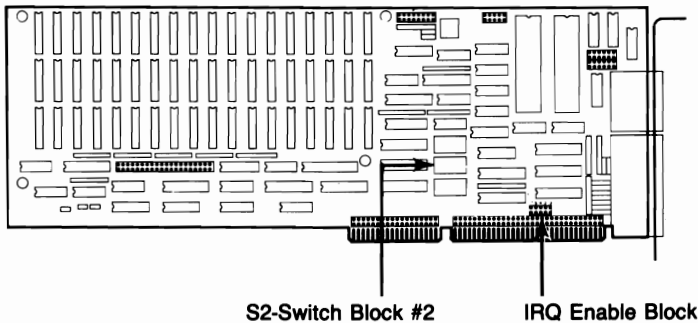

Figure 6-1. Location of Switch Block #2 and IRQ Enable Block

All the possible *Advantage!* parallel port configurations are shown in Tables 6-4 and 6-5 below. Use Table 6-4 for an AT with a monochrome-type display card with a built-in printer adapter port, or use Table 6-5 for an AT with a color-type display card without a built-in printer adapter port.

Table 6-4. Parallel Port Configuration with Monochrome-Type Display Card Installed

Number of Parallel Ports Already in the AT (with Monochrome Card)	Switch Block #2	IRQ Jumpers	Function of Advantage! Parallel Port
1			LPT2
2			LPT3 (No Interrupt)
3			Disabled

Table 6-5. Parallel Port Configuration with Color-Type Display Card Installed

Number of Parallel Ports Already in the AT	Switch Block #2	IRQ Jumpers	Function of Advantage! Parallel Port
0			LPT1
1			LPT2
2			Disabled
3			Disabled

6.3 Advantage! Factory Default Parallel Port Configuration

The factory-set default configuration of the *Advantage!* parallel port is for an AT with a color-type display card (no other parallel port installed). This configuration is shown in Figure 6-2 below.

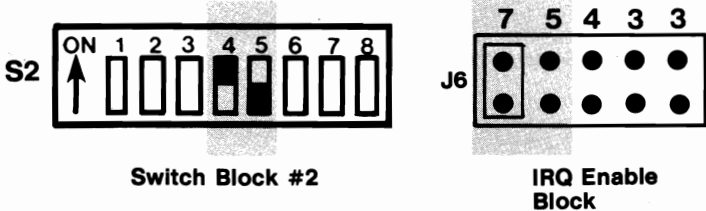

Figure 6-2. Default Configuration of Parallel Port

SECTION 7

GAME ADAPTER PORT

The game adapter port provides an interface for connecting one or two joysticks to the AT. With appropriate software, this device can be used for cursor control, as well as graphics development and interactive games.

7.1 Technical Information About the Game Port

The following technical information applies to the game adapter port on the *Advantage!*.

7.1.1 I/O Address and Interrupt Assignments

The game adapter port is assigned I/O addresses 200-207 hex. No hardware interrupt line is used by the game port.

7.1.2 Game Adapter Port Pinouts

The game adapter port uses a DB15S (socket or female) interface connector. The pinout for this port is shown in Table 7-1.

Table 7-1. Game Adapter Port Pinouts

	Advantage! J4 Pin No.	DB15 Pin Number	Signal Name
(Joystick A)	1	1	+5VDC
	3	2	Button 1
	5	3	X Axis
	7	4	Ground
	9	5	Ground
	11	6	Y Axis
	13	7	Button 2
	15	8	+5VDC
(Joystick B)	2	9	+5VDC
	4	10	Button 3
	6	11	X Axis
	8	12	Ground
	10	13	Y Axis
	12	14	Button 4
	14	15	+5VDC

A single joystick may be connected directly to the DB15 connector. To connect two joysticks, you will need a special "Y" connector adapter cable. Consult your dealer for further information.

7.2 Advantage! Game Adapter Port Configuration

Position 6 of Switch Block #2 on the *Advantage!* card controls the configuration of the game port. The location and function of Switch Block #2 is shown in Figure 7-1.

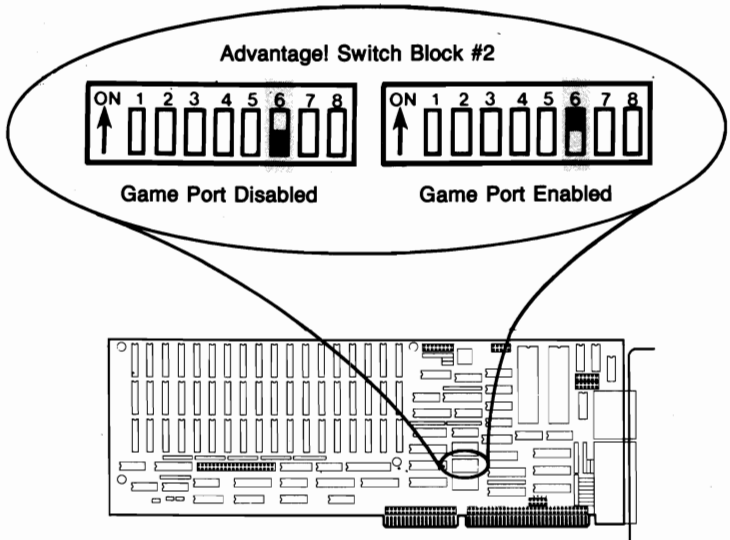

Figure 7-1. Game Adapter Port Enable/Disable Switch

NOTE

The switch should be "OFF" (disabled) unless your *Advantage!* has the optional game port installed.

7.3 Software Compatibility

The game port is totally software-compatible with the IBM game adapter. However, because a joystick is an analog device, there may be variations among different joysticks, and some software may not function as expected even though the game port is functioning properly. It is therefore recommended that you make sure that your software includes a joystick-centering function to compensate for differences between joysticks.

The program listing in Section 7.4 can be used to test for proper operation of the game port on the *Advantage!*.

7.4 Game Port Diagnostic Testing

The *Advantage!* game port can be tested using the IBM diagnostics. However, because of a problem in the diagnostic program, the port may not always show up on the listing of installed devices. If this is the case, you can use the program below to test the port. This program requires the use of BASICA (not BASIC).

```
10 DEFINT A-Z:KEY OFF:CLS:STRIG ON:SCREEN 2
20 PRINT "X1","Y1","S1";"S3"
30 X1 = STICK(0):Y1 = STICK(1)
40 A = STRIG(1):C = STRIG(5)
50 LOCATE 3:PRINT X1,Y1,A;C
60 GOTO 30
```

When you run the above program, moving the joystick in the X-plane (left-right) causes a change in the "X1" readout, while moving the joystick in the Y-plane (up-down) causes a change in the "Y1" readout. Pressing the switch (either one or two, depending on your joystick) causes the "S1" or "S3" readouts to switch between 0 and -1. Depending on the quality of your joystick, you may not be able to get a zero reading in the X and Y planes when running the program. This is normal and no cause for alarm.

7.5 Installing the Game Port Adapter Upgrade Kit

An upgrade kit is offered by AST for field installation of the *Advantage!* game adapter port. This upgrade kit, AST Model Number ADV-000G, contains the special components necessary for proper function of the game port in an AT. It is available through your AST dealer. Instructions for installing the optional game port are supplied with the upgrade kit.

APPENDIX A

RECOMMENDED SERIAL PORT WIRING

Appendix A gives the wiring configurations you need to interface your *Advantage!* serial port to these serial devices:

1. Modems (such as the Hayes Stack Smart modem, Novation Cat, and UDS).
2. These serial printers: NEC 7700 series, TI 810 series, Epson MX-100-3, Brother HR-1, OKIDATA Microline 83A, OKIDATA Microline 84, and the Anadex 9501.
3. The Qume Sprint 9/45 and 9/55 serial printers.
4. CRTs and printers that run at low baud rates (110-300 baud).
5. The Diablo 620 printer.
6. The Diablo 630 printer.
7. These serial printers: Smith-Corona TP-1, Epson MX-80, and IDS Prism.
8. The Hewlett-Packard H-P 7470A plotter.

For all of these devices:

1. The interface diagrams in this appendix refer to DTE interfaces (such as the *Advantage!* serial port) only.
2. A DB25S (female/socket) connector is used for the *Advantage!* side and a DB25P (male/plug) connector for the serial device side. If you use a device that requires a DB25S (for example, the NEC 7720), you must use an adapter to connect to the port.

Recommended Serial Port Wiring

To interface other products to your *Advantage!* serial port, see Appendix B (for general information) and your serial device manual. You can also contact the serial device manufacturer for advice on connecting the device to an IBM PC-AT asynchronous serial port.

NOTE

The pin assignments listed in this appendix are for DB25 connectors; they assume that you are using an adapter cable to interface the *Advantage!* serial port DB9P connector to a serial device cable DB25S connector. If you are not using an adapter cable (are going directly from the DB9 to another DB9 on a serial device cable), then reference Table 5-1 for DB9 pin assignments, and substitute the numbers listed there for the numbers given in this appendix.

Modems

The interface diagram below illustrates the interface between the *Advantage!* serial port and modem devices such as the Hayes Stack Smart modem, Novation Cat, and UDS.

<i>Advantage!</i> Serial Port Connector	Modem Port Connector
1	1
2	2
3	3
4	4
5	5
6	6
7	7
8	8
20	20
22	22

Serial Printers

The interface diagram below illustrates the suggested wiring for the NEC 7700 series, TI 810 series, Epson MX-100-3, Brother HR-1, OKIDATA Microline 83A, OKIDATA Microline 84, and Anadex 9501 serial printers. This wiring allows the printer to inform the PC-AT that its receiving buffer is full.

<i>Advantage!</i> Serial Port Connector	Printer Port Connector	
1	1	
2	3	
3	2	
4	5	
5	11	{TI, Brother, Epson OKIDATA only
5	19	{NEC, Adadex only
6 & 8	20	
7	7	
20	6 & 8	

NOTE

Advantage! pins 6 and 8 are jumpered together and connected to printer pin 20. Printer pins 6 and 8 are jumpered together and connected to *Advantage!* pin 20.

Serial Printers

The interface diagram below illustrates the suggested wiring for the Qume 9/45 and Qume 9/55 serial printers. This wiring allows the Qume printer to inform the PC-AT that its receiving buffer is full.

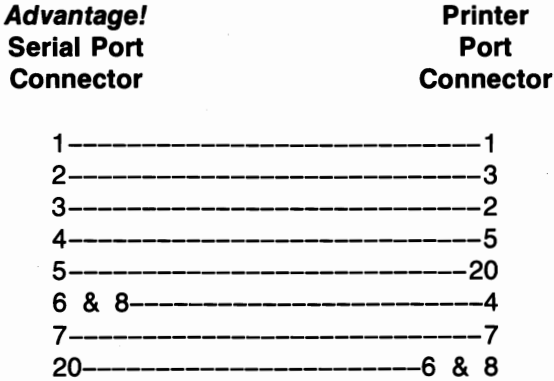

NOTE

Advantage! pins 6 and 8 are jumpered together and connected to printer pin 4. Printer pins 6 and 8 are jumpered together and connected to *Advantage!* pin 20.

Slow CRTs and Printers

The following interface diagram illustrates the suggested wiring for CRTs and printers that running at low baud rates (110-300 baud). This wiring does not use standard EIA RS-232C handshaking, but it should work with most CRTs and some printers.

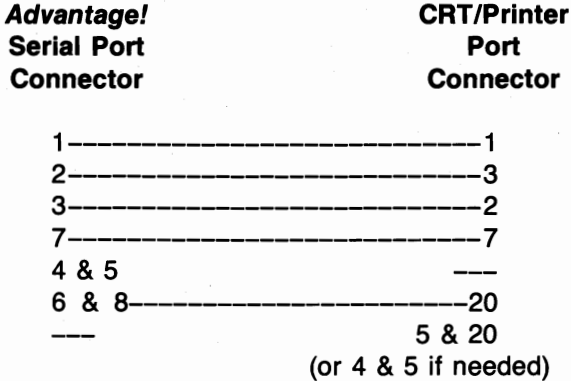

NOTE

Advantage! pins 4 and 5 are jumpered together, and *Advantage!* pins 6 and 8 are jumpered together. You can jumper together CRT/printer pins 5 and 20 or 4 and 5. Consult the user's manual for your CRT or printer for your specific configuration.

The Diablo 620 Printer

The interface diagram below illustrates the suggested wiring for the Diablo 620 serial printer. This arrangement allows the Diablo to inform the PC-AT side of the interface that its receive buffer is full.

Advantage!
Serial Port
Connector

Diablo 620
Serial Port
Connector

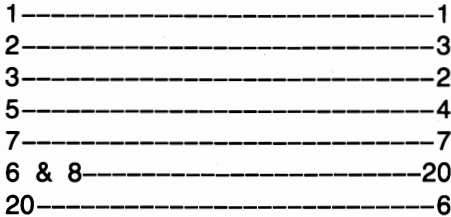

NOTE

Advantage! pins 6 and 8 are jumpered together and connected to Diablo 620 pin 20.

Diablo 630 Printers

There are several different versions of the Diablo 630 printer. AST Research has had the best success with the following serial interface wiring:

Advantage! Serial Port Connector	Diablo 630 Serial Port Connector
1	1
2	3
3	2
5	11
7	7
6 & 8 & 20	6 (or 6 & 4)

NOTE

If this wiring does not work for your 630 Diablo printer, contact Diablo or your printer dealer.

Serial Printers

The interface diagram below illustrates the suggested wiring for these serial printers: Smith-Corona TP-1, Epson MX-80, and IDS Prism. This arrangement gives these printers sufficient control over output from the PC-AT side of the interface to allow both devices to remain in a ready state, while pins 4 and 5 actually control the flow of data from one side to the other.

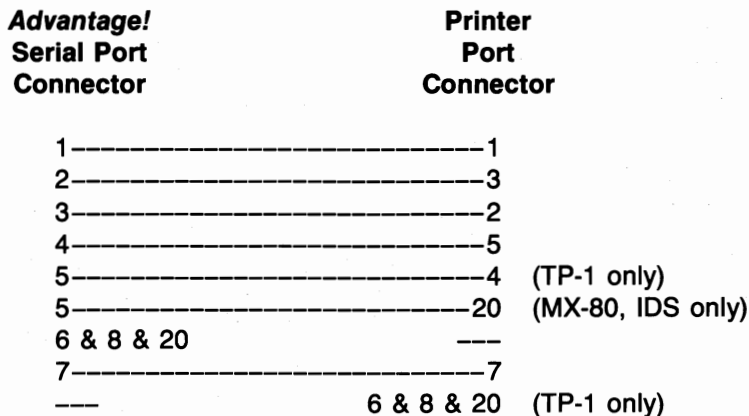

NOTE

Advantage! pins 6, 8, and 20 are jumpered together and TP-1 printer pins 6, 8, and 20 are jumpered together.

Hewlett-Packard H-P 7470A Plotter

The interface diagram below illustrates the suggested wiring for the Hewlett-Packard H-P 7470A plotter.

Advantage! Serial Port Connector	H-P 7470A Serial Port Connector
1	1
3	2
2	3
7	7
5	20
6 & 8 & 20	---

NOTE

Advantage! pins 6, 8, and 20 are jumpered together.

(This page intentionally left blank)

APPENDIX B

GENERAL SERIAL INTERFACE WIRING INFORMATION

This appendix provides general information for wiring your AST Research *Advantage!* serial communications ports to remote devices using the Electronic Industry Association (EIA) RS-232C standard interface.

NOTE

The *Advantage!* does not support the current-loop teletype interface.

The EIA RS-232C standard describes the arrangement of control and data signals on both sides of a serial communications interface. Control signals are used to control the flow of data, and data signals contain the information to be transmitted. The RS-232C standard describes an ideal case of a data terminal connected to a modem. A modem (MOdulator/ DEModulator) is a communications device. The communications device interfaces to a transmission medium (for example, phone lines) that carries the signal to a remote, such as a modem connected to a port on another DTE port or the communications element of a mainframe computer system.

The RS-232C standard describes the signals that travel between Data Terminal Equipment (DTE) and Data Communications Equipment (DCE). The signals control the exchange of data to and from the local modem and local terminal. These signals travel on separate wires from pins on the DTE side (terminal) to pins on the DCE side (modem).

NOTE

The pin assignments listed in this appendix are for DB25 connectors; they assume that you are using an adapter cable to interface the *Advantage!* serial port DB9P connector to a serial device cable DB25S connector. If you are not using an adapter cable (are going directly from the DB9 to another DB9 on a serial device cable), then reference Table 5-1 for DB9 pin assignments, and substitute the numbers listed there for the numbers given in this appendix.

For asynchronous applications (such as the *Advantage!* serial communications port) you use only eight or nine signals between the DTE (your serial port) and the DCE (a modem or serial device DCE port).

Interfacing DTE to DCE

To familiarize yourself with the signal and sequence requirements of the RS-232C standard, imagine that you want to connect the serial port on your AST Research board (DTE) to a telephone modem (DCE). A correctly configured DCE/DTE interface is wired straight across: DTE pin 20 wired to DCE pin 20, pin 2 to pin 2, and so forth. The two devices can then interact to function properly (this interaction is called "handshaking").

When the PC-AT serial port (DTE) wants to transmit data it raises the voltage on pin 20; pin 20 carries the DTR (Data Terminal Ready) signal. This voltage travels to DCE pin 20 where the modem (DCE) interprets it to mean that a communications link is being requested by the terminal device.

If an open phone line exists, the DCE brings up two lines on its side of the interface: DSR (Data Set Ready, pin 6) and DCD (Data Carrier Detect, pin 8). When the DTE (your PC-AT port) sees high voltage at its pins 6 and 8, it can then bring

If an open phone line exists, the DCE brings up two lines on its side of the interface; DSR (Data Set Ready, pin 6) and DCD (Data Carrier Detect, pin 8). When the DTE (your PC-AT port) sees high voltage at its pins 6 and 8, it can then bring up pin 4, RTS (Request To Send). RTS tells the DCE that the DTE has data to transmit to it. The DCE checks that it is ready to receive data; if so, it brings up pin 5, CTS (Clear To Send).

Once the DTE sees voltage on its pin 5, it starts transmitting on the wire connected to pin 2, TxD (Transmit Data). DTE Pin 3, RxD (Receive Data) receives any incoming signals.

Some modems have an automatic answer mode that uses the signal RI (Ring Indicator, pin 22) to alert the terminal that incoming data is due. The terminal uses DTR to respond to RI.

CAUTION

To help protect your equipment from damage, be sure to connect the ground wires (pins 1 and 7).

General Serial Interface Wiring Information

Figure B-1 illustrates an ideal DTE to DCE interface, including signals, signal directions, and sequence (top to bottom).

Notice that the DTE (PC-AT side) input signals include DCD, DSR, CTS, and RxD. The DTE output signals include DTR and RTS. The interface must handle these signals before the DTE can transmit or receive data.

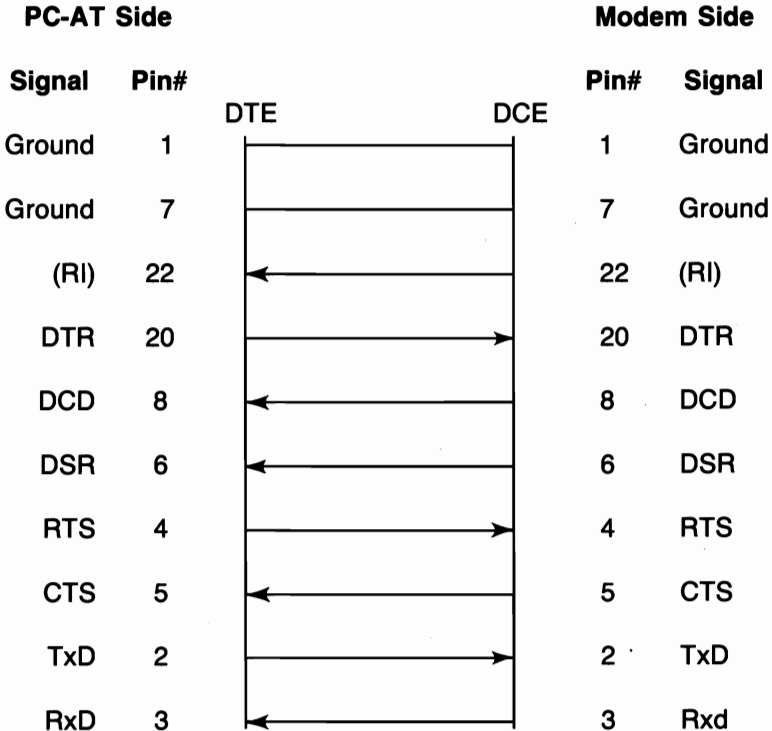

Figure B-1. Ideal Case: DTE to DCE Interface

Figure B-1 illustrates the interface signals in order of occurrence (top to bottom). From the DTE's standpoint, it must send DTR, see DCD, see DSR, send RTS, and see CTS before transmitting or receiving data: the inputs must have voltage applied to them for the interface to become operational. (The outputs matter only in that they are inputs to the DCE side of the interface.) The hardware that controls the DTE serial interface does not release data to the communications link until it has received the proper set and sequence of signals.

You can think of certain pins on one side of the interface as “functional pairs”; for example, when the AST serial port sends DTR, it expects to see DSR (and DCD) raised in response. DTR and DSR are signal and response to one another: they act as a pair. The same is true of RTS and CTS, and of TxD and RxD.

Interfacing DTE to DTE

Many devices, such as serial printers, are set up as DTE. To output data from your PC-AT serial port (also DTE) to a serial printer or other DTE device, you must wire a DTE to DTE interface. A DTE to DTE interface must fool each side of the link into thinking that it is receiving “response” inputs from a DCE. The input voltages must be present, and they must occur in the correct sequence (the correct sequence varies from device to device).

Each side of a DTE to DTE interface acts like the DTE side of a DTE to DCE interface. Both sides of the DTE to DTE interface must send and receive these signals in this sequence before sending or receiving data:

- Send DTR
- Receive DCD and DSR
- Send RTS
- Receive CTS

General Serial Interface Wiring Information

Figure B-2 illustrates a DTE to DTE interface, including signals, signal directions, and sequence.

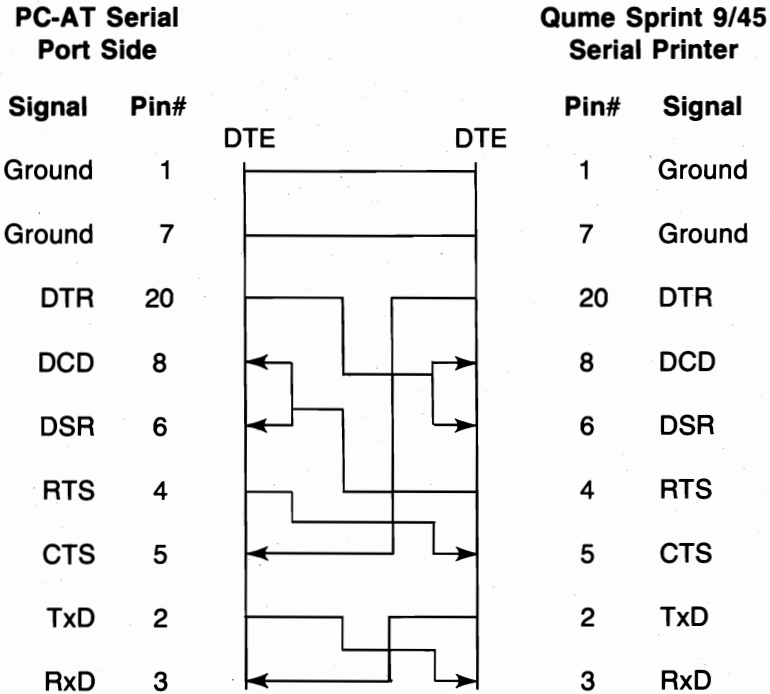

Figure B-2. Typical DTE to DTE Interface

Notice that the necessary input signals are supplied to both sides. DCD, DSR, and CTS have voltage applied to them on either side.

This example does change the ideal sequence by having the printer DTR signal drive PC-AT signal CTS; however, the integrated circuit that controls the PC side (INS 8250) is fairly flexible in reading the sequence of inputs. The reason for the sequence change is that when the Qume printer receive buffer is about to fill up it drops its DTR signal. To avoid losing data by overflowing the printer's receive buffer, we halt PC data output immediately by dropping the CTS input to the PC side immediately. The remainder of the interface then "idles" until the printer raises DTR again. Remember that this is a specific case for Qume serial printers.

Figure B-3 illustrates another example of interfacing a serial DTE printer to the PC's *Advantage!* serial port.

AST Serial Port DTE to NEC 7700 Series Serial DTE Printer

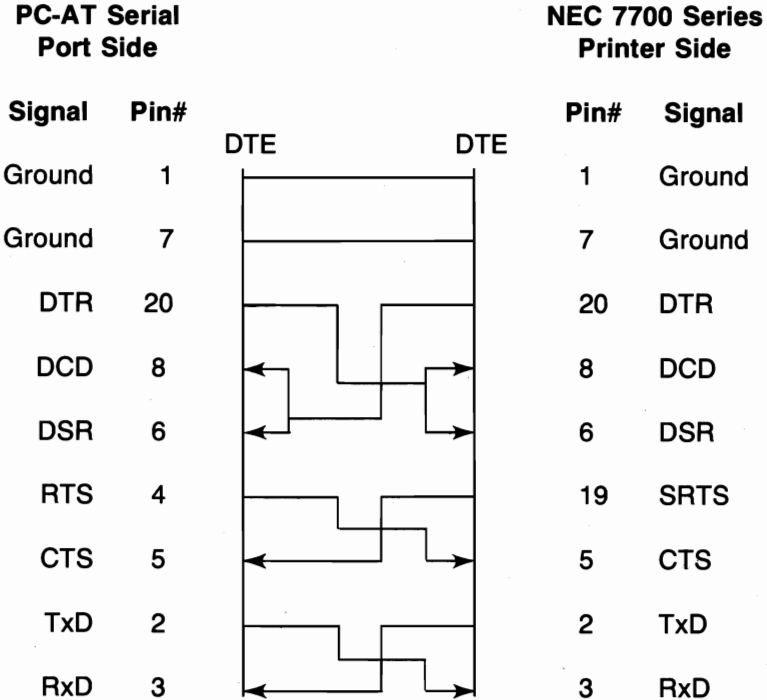

Figure B-3. DTE to DTE (NEC 7700 Printer) Interface

In this case, the printer uses SRTS (Secondary Request To Send, pin 19) instead of pin 4 (RTS); apart from that exception, Figure B-3 follows the ideal DTE input and sequence rules.

The advantage of the interface shown in Figure B-3 is that every pin is driven by its functional counterpart on the other side of the interface; the functionally related signal pairs include DTR/DSR, RTS/CTS, and TxD/RxD. This should also hold true for the interface you design.

Design Aids

Your serial device manual tells you how the device uses the RS-232C line signals and which pin numbers supply which signals. You can also contact the device manufacturer for further information on interfacing to an IBM PC-AT asynchronous serial port. Serial ports on all AST Research boards are IBM-compatible.

Your dealer can direct you to a parts store that carries the products you need to construct an interface cable. You must use the correct type of 9- and 25-pin connectors (male or female) to connect both ends properly. Your *Advantage!* serial port end requires a DB9S (female/socket type) connector. The DB9S can be attached to a serial device cable DB9P, or (as in most cases) connect via an adapter cable to a DB25P connector that attaches to a DB25S connector on a serial device cable.

To wire your serial interface signals properly, we suggest you use the form shown in Figure B-4 as a design aid:

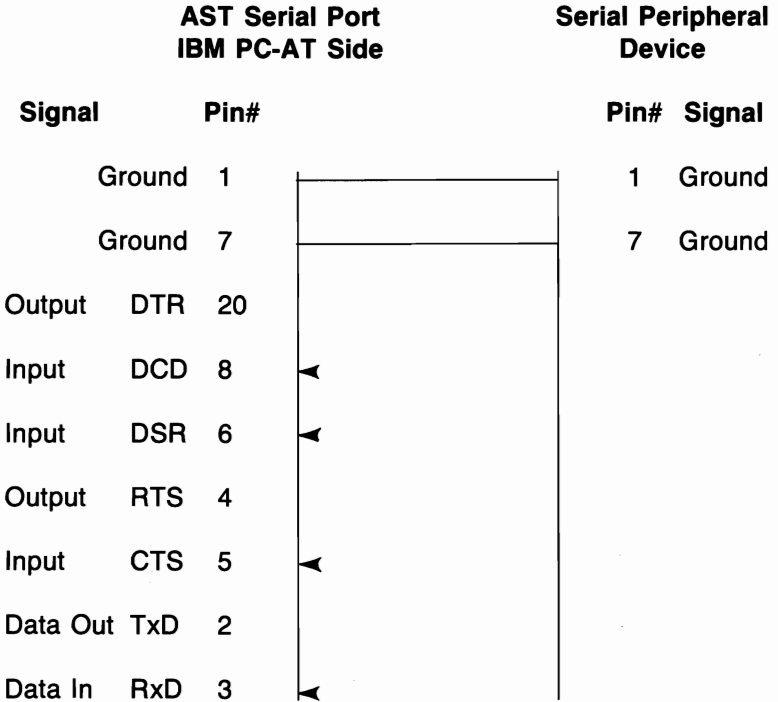

Figure B-4. Serial Interface Form

If you plan to use several different serial devices on your serial port, you can make a separate interface assembly for each device. That way you can use the same long cable to connect your PC-AT to any of these devices.

(This page intentionally left blank)

APPENDIX C

SWITCHING BETWEEN PARALLEL PRINTER PORTS

This appendix gives you programs you can use in a batch file to direct printer output normally designated for the device attached to port LPT1, to instead be routed to the device attached to port LPT2 or LPT3. (The program also directs output, normally designated for the device attached to port LPT2 or LPT3, to instead be routed to the device attached to port LPT1.) For more information on creating a batch file, see your IBM Personal Computer *DOS* manual.

The programs in this appendix are particularly useful if your application program (a word processing program, for example) is capable of sending print output to only one parallel port. You might also use this program when your LPT1 printer (call it printer #1) is down for service, or when you want to take advantage of the type style or speed of the printer attached to LPT2 or LPT3 (call it printer #2 or #3). This program allows you to quickly switch between outputs without having to alter your hardware interface or change each line that specifies LPT1, LPT2, or LPT3 as the output port designation in your programs.

If your printers are not configured to the same parameters, as defined in the PC-DOS MODE command, you must add two MODE statements when switching devices.

Notice that the "swap" program below is written in BASIC. Since the printer port swap is best handled in DOS, BASIC is invoked within the .BAT file. No RUN command is required when the BASIC call and the program file name occur on the same line (**BASIC LPTSWAP**). Consult your IBM Personal Computer *BASIC* manual if you have any questions about entering and saving the LPTSWAP.BAS program.

Switching Between LPT1 and LPT2

The following DOS batch file and BASIC program will redirect printer output from LPT1 to LPT2 or vice versa, depending on which port is being used at the time.

LPTSWAP.BAT (or a name of your choosing) with the following:

```
MODE LPT1:[parameters for printer #2 (if needed)]  
MODE LPT2:[parameters for printer #1 (if needed)]  
BASIC LPTSWAP
```

LPTSWAP is a BASIC program, as shown below. The comments are included for clarification and need not be included in the actual program:

```
10 DEF SEG = &H40           ' finds port address table  
20 A = PEEK (8): B = PEEK (9) ' save LPT1 address  
30 POKE 8,PEEK (10):       ' LPT2 address to LPT1  
   POKE 9,PEEK (11)  
40 POKE 10,A: POKE 11,B   ' LPT1 address to LPT2  
50 SYSTEM                 ' return to DOS
```

Omit statement 50 if you will be LPRINTing from BASIC.

To restore LPT1 to LPT1 and LPT2 to LPT2:

Use the following program, LPTRSTR, to restore your parallel printer ports to their original arrangement. Be sure to restore the proper parameters using a new batch file and MODE statements.

LPTRSTR.BAT (for example) is as follows:

```
MODE LPT1:[parameters for printer #1 (if needed)]  
MODE LPT2:[parameters for printer #2 (if needed)]  
BASIC LPTSWAP
```

Switching Between LPT1 and LPT3

The following DOS batch file and BASIC program will redirect printer output from LPT1 to LPT3 or vice versa, depending on which port is being used at the time.

LPTSWAP.BAT (or a name of your choosing) with the following:

```
MODE LPT1:[parameters for printer #3 (if needed)]
MODE LPT3:[parameters for printer #1 (if needed)]
BASIC LPTSWAP
```

LPTSWAP is a BASIC program, as shown below. The comments are included for clarification and need not be included in the actual program:

```
10 DEF SEG = &H40           ' finds port address table
20 A = PEEK (8): B = PEEK (9) ' save LPT1 address
30 POKE 8,PEEK (12):       ' LPT3 address to LPT1
   POKE 9,PEEK (13)
40 POKE 12,A: POKE 13,B   ' LPT1 address to LPT3
50 SYSTEM                 ' return to DOS
```

Omit statement 50 if you will be LPRINTing from BASIC.

To restore LPT1 to LPT1 and LPT3 to LPT3:

Use the following program, LPTRSTR, to restore your parallel printer ports to their original arrangement. Be sure to restore the proper parameters using a new batch file and MODE statements.

LPTRSTR.BAT is as follows:

```
MODE LPT1:[parameters for printer #1 (if needed)]
MODE LPT3:[parameters for printer #3 (if needed)]
BASIC LPTSWAP
```

(This page intentionally left blank)

APPENDIX D

***ADVANTAGE!* AND AT MEMORY CONFIGURATION INFORMATION**

This appendix contains information relating to memory configuration of the *Advantage!*:

- Table D-1 can be used to compute the amount of base and expansion memory in the AT, based upon the configuration of the *Advantage!*.
- Table D-2 lists all possible starting addresses of the *Advantage!* and the corresponding settings for Switch Block #3 on the board.

In Table D-2, the first two table entries are for Split Memory Addressing in an AT with 256K or 512K respectively. All other switch settings would put the *Advantage!* into the Contiguous addressing mode.

Table D-1. Split Memory Addressing Memory Allocation

TOTAL MEMORY ROWS POPULATED	NUMBER ROWS 64K CHIPS	NUMBER ROWS 256K CHIPS	TOTAL ADVTG. MEMORY (KB)	256K AT			512K AT		
				BASE MEM.	EXP. MEM.	TOTAL MEM.	BASE MEM.	EXP. MEM.	TOTAL MEM.
1	1	0	128	384	0	384	640	0	640
1	0	1	512	640	128	768	640	384	1024
2	2	0	256	512	0	512	640	128	768
2	1	1	640	640	256	896	640	512	1152
2	0	2	1024	640	640	1280	640	896	1536
3	3	0	384	640	0	640	640	256	896
3	2	1	768	640	384	1024	640	640	1280
3	1	2	1152	640	768	1408	640	1024	1664
3	0	3	1536	640	1152	1792	640	1408	2048
4	4	0	512	640	128	768	640	384	1024
4	3	1	896	640	512	1152	640	768	1408
4	2	2	1280	640	896	1536	640	1152	1792
4	1	3	1664	640	1280	1920	640	1536	2176
4	0	4	2048	640	1664	2304	640	1920	2560
5	5	0	640	640	256	896	640	512	1152
5	4	1	896	640	512	1152	640	768	1408
5	3	2	1408	640	1024	1664	640	1280	1920
5	2	3	1792	640	1408	2048	640	1664	2304
5	1	4	2176	640	1792	2432	640	2048	2688
5	0	5	2560	640	2176	2816	640	2432	3072
6	6	0	768	640	384	1024	640	640	1280
6	5	1	1152	640	768	1408	640	1024	1664
6	4	2	1536	640	1152	1792	640	1408	2048
6	3	3	1920	640	1536	2176	640	1792	2432
6	2	4	2304	640	1920	2560	640	2176	2816
6	1	5	2688	640	2304	2944	640	2560	3200
6	0	6	3072	640	2688	3328	640	2944	3584

Conversion Chart for calculating the amount of base memory and expansion memory in the AT when using split memory addressing on the **Advantage!**

Table D-2. Switch Block #2 Settings (Starting Address)

ADVANTAGE! START ADDRESS (MEGABYTES)	ADVANTAGE! START ADDRESS (K-BYTES)	ADVANTAGE! START ADDRESS (HEXADECIMAL)	ADVANTAGE! SWITCH BLOCK #3						
			SW1	SW2	SW3	SW4	SW5	SW6	SW7
0.250	256	040000	ON	ON	ON	ON	ON	OFF	ON
0.500	512	080000	ON	ON	ON	ON	OFF	ON	ON
1.000	1024	100000	ON	ON	ON	OFF	ON	ON	ON
1.125	1152	120000	ON	ON	ON	OFF	ON	ON	OFF
1.250	1280	140000	ON	ON	ON	OFF	ON	OFF	ON
1.375	1408	160000	ON	ON	ON	OFF	ON	OFF	OFF
1.500	1536	180000	ON	ON	ON	OFF	OFF	ON	ON
1.625	1664	1A0000	ON	ON	ON	OFF	OFF	ON	OFF
1.750	1792	1C0000	ON	ON	ON	OFF	OFF	OFF	ON
1.875	1920	1E0000	ON	ON	ON	OFF	OFF	OFF	OFF
2.000	2048	200000	ON	ON	OFF	ON	ON	ON	ON
2.125	2176	220000	ON	ON	OFF	ON	ON	ON	OFF
2.250	2304	240000	ON	ON	OFF	ON	ON	OFF	ON
2.375	2432	260000	ON	ON	OFF	ON	ON	OFF	OFF
2.500	2560	280000	ON	ON	OFF	ON	OFF	ON	ON
2.625	2688	2A0000	ON	ON	OFF	ON	OFF	ON	OFF
2.750	2816	2C0000	ON	ON	OFF	ON	OFF	OFF	ON
2.875	2944	2E0000	ON	ON	OFF	ON	OFF	OFF	OFF
3.000	3072	300000	ON	ON	OFF	OFF	ON	ON	ON
3.125	3200	320000	ON	ON	OFF	OFF	ON	ON	OFF
3.250	3328	340000	ON	ON	OFF	OFF	ON	OFF	ON
3.375	3456	360000	ON	ON	OFF	OFF	ON	OFF	OFF
3.500	3584	380000	ON	ON	OFF	OFF	OFF	ON	ON
3.625	3712	3A0000	ON	ON	OFF	OFF	OFF	ON	OFF
3.750	3840	3C0000	ON	ON	OFF	OFF	OFF	OFF	ON
3.875	3968	3E0000	ON	ON	OFF	OFF	OFF	OFF	OFF
4.000	4096	400000	ON	OFF	ON	ON	ON	ON	ON
4.125	4224	420000	ON	OFF	ON	ON	ON	ON	OFF
4.250	4352	440000	ON	OFF	ON	ON	ON	OFF	ON
4.375	4480	460000	ON	OFF	ON	ON	ON	OFF	OFF
4.500	4608	480000	ON	OFF	ON	ON	OFF	ON	ON
4.625	4736	4A0000	ON	OFF	ON	ON	OFF	ON	OFF
4.750	4864	4C0000	ON	OFF	ON	ON	OFF	OFF	ON
4.875	4992	4E0000	ON	OFF	ON	ON	OFF	OFF	OFF
5.000	5120	500000	ON	OFF	ON	OFF	ON	ON	ON
5.125	5248	520000	ON	OFF	ON	OFF	ON	ON	OFF
5.250	5376	540000	ON	OFF	ON	OFF	ON	OFF	ON
5.375	5504	560000	ON	OFF	ON	OFF	ON	OFF	OFF
5.500	5632	580000	ON	OFF	ON	OFF	OFF	ON	ON
5.625	5760	5A0000	ON	OFF	ON	OFF	OFF	ON	OFF
5.750	5888	5C0000	ON	OFF	ON	OFF	OFF	OFF	ON
5.875	6016	5E0000	ON	OFF	ON	OFF	OFF	OFF	OFF
6.000	6144	600000	ON	OFF	OFF	ON	ON	ON	ON

Table D-2. Switch Block #2 Settings (Starting Address) Continued

ADVANTAGE! START ADDRESS (MEGABYTES)	ADVANTAGE! START ADDRESS (K-BYTES)	ADVANTAGE! START ADDRESS (HEXADECIMAL)	ADVANTAGE! SWITCH BLOCK #3						
			SW1	SW2	SW3	SW4	SW5	SW6	SW7
6.125	6272	620000	ON	OFF	OFF	ON	ON	ON	OFF
6.250	6400	640000	ON	OFF	OFF	ON	ON	OFF	ON
6.375	6528	660000	ON	OFF	OFF	ON	ON	OFF	OFF
6.500	6656	680000	ON	OFF	OFF	ON	OFF	ON	ON
6.625	6784	6A0000	ON	OFF	OFF	ON	OFF	ON	OFF
6.750	6912	6C0000	ON	OFF	OFF	ON	OFF	OFF	ON
6.875	7040	6E0000	ON	OFF	OFF	ON	OFF	OFF	OFF
7.000	7168	700000	ON	OFF	OFF	OFF	ON	ON	ON
7.125	7296	720000	ON	OFF	OFF	OFF	ON	ON	OFF
7.250	7424	740000	ON	OFF	OFF	OFF	ON	OFF	ON
7.375	7552	760000	ON	OFF	OFF	OFF	ON	OFF	OFF
7.500	7680	780000	ON	OFF	OFF	OFF	OFF	ON	ON
7.625	7808	7A0000	ON	OFF	OFF	OFF	OFF	ON	OFF
7.750	7936	7C0000	ON	OFF	OFF	OFF	OFF	OFF	ON
7.875	8064	7E0000	ON	OFF	OFF	OFF	OFF	OFF	OFF
8.000	8192	800000	OFF	ON	ON	ON	ON	ON	ON
8.125	8320	820000	OFF	ON	ON	ON	ON	ON	OFF
8.250	8448	840000	OFF	ON	ON	ON	ON	OFF	ON
8.375	8576	860000	OFF	ON	ON	ON	ON	OFF	OFF
8.500	8704	880000	OFF	ON	ON	ON	OFF	ON	ON
8.625	8832	8A0000	OFF	ON	ON	ON	OFF	ON	OFF
8.750	8960	8C0000	OFF	ON	ON	ON	OFF	OFF	ON
8.875	9088	8E0000	OFF	ON	ON	ON	OFF	OFF	OFF
9.000	9216	900000	OFF	ON	ON	OFF	ON	ON	ON
9.125	9344	920000	OFF	ON	ON	OFF	ON	ON	OFF
9.250	9472	940000	OFF	ON	ON	OFF	ON	OFF	ON
9.375	9600	960000	OFF	ON	ON	OFF	ON	OFF	OFF
9.500	9728	980000	OFF	ON	ON	OFF	OFF	ON	ON
9.625	9856	9A0000	OFF	ON	ON	OFF	OFF	ON	OFF
9.750	9984	9C0000	OFF	ON	ON	OFF	OFF	OFF	ON
9.875	10112	9E0000	OFF	ON	ON	OFF	OFF	OFF	OFF
10.000	10240	A00000	OFF	ON	OFF	ON	ON	ON	ON
10.125	10368	A20000	OFF	ON	OFF	ON	ON	ON	OFF
10.250	10496	A40000	OFF	ON	OFF	ON	ON	OFF	ON
10.375	10624	A60000	OFF	ON	OFF	ON	ON	OFF	OFF
10.500	10752	A80000	OFF	ON	OFF	ON	OFF	ON	ON
10.625	10880	AA0000	OFF	ON	OFF	ON	OFF	ON	OFF
10.750	11008	AC0000	OFF	ON	OFF	ON	OFF	OFF	ON
10.875	11136	AE0000	OFF	ON	OFF	ON	OFF	OFF	OFF
11.000	11264	B00000	OFF	ON	OFF	OFF	ON	ON	ON
11.125	11392	B20000	OFF	ON	OFF	OFF	ON	ON	OFF
11.250	11520	B40000	OFF	ON	OFF	OFF	ON	OFF	ON
11.375	11648	B60000	OFF	ON	OFF	OFF	ON	OFF	OFF
11.500	11776	B80000	OFF	ON	OFF	OFF	OFF	ON	ON

Table D-2. Switch Block #2 Settings (Starting Address) Continued

ADVANTAGE! START ADDRESS (MEGABYTES)	ADVANTAGE! START ADDRESS (K-BYTES)	ADVANTAGE! START ADDRESS (HEXADECIMAL)	ADVANTAGE! SWITCH BLOCK #3							
			SW1	SW2	SW3	SW4	SW5	SW6	SW7	
11.625	11904	BA0000	OFF	ON	OFF	OFF	OFF	ON	OFF	
11.750	12032	BC0000	OFF	ON	OFF	OFF	OFF	OFF	ON	
11.875	12160	BE0000	OFF	ON	OFF	OFF	OFF	OFF	OFF	
12.000	12288	C00000	OFF	OFF	ON	ON	ON	ON	ON	
12.125	12416	C20000	OFF	OFF	ON	ON	ON	ON	OFF	
12.250	12544	C40000	OFF	OFF	ON	ON	ON	OFF	ON	
12.375	12672	C60000	OFF	OFF	ON	ON	ON	OFF	OFF	
12.500	12800	C80000	OFF	OFF	ON	ON	OFF	ON	ON	
12.625	12928	CA0000	OFF	OFF	ON	ON	OFF	ON	OFF	
12.750	13056	CC0000	OFF	OFF	ON	ON	OFF	OFF	ON	
12.875	13184	CE0000	OFF	OFF	ON	ON	OFF	OFF	OFF	
13.000	13312	D00000	OFF	OFF	ON	OFF	ON	ON	ON	
13.125	13440	D20000	OFF	OFF	ON	OFF	ON	ON	OFF	
13.250	13568	D40000	OFF	OFF	ON	OFF	ON	OFF	ON	
13.375	13696	D60000	OFF	OFF	ON	OFF	ON	OFF	OFF	
13.500	13824	D80000	OFF	OFF	ON	OFF	OFF	ON	ON	
13.625	13952	DA0000	OFF	OFF	ON	OFF	OFF	ON	OFF	
13.750	14080	DC0000	OFF	OFF	ON	OFF	OFF	OFF	ON	
13.875	14208	DE0000	OFF	OFF	ON	OFF	OFF	OFF	OFF	
14.000	14336	E00000	OFF	OFF	OFF	ON	ON	ON	ON	
14.125	14464	E20000	OFF	OFF	OFF	ON	ON	ON	OFF	
14.250	14592	E40000	OFF	OFF	OFF	ON	ON	OFF	ON	
14.375	14720	E60000	OFF	OFF	OFF	ON	ON	OFF	OFF	
14.500	14848	E80000	OFF	OFF	OFF	ON	OFF	ON	ON	
14.625	14976	EA0000	OFF	OFF	OFF	ON	OFF	ON	OFF	
14.750	15104	EC0000	OFF	OFF	OFF	ON	OFF	OFF	ON	
14.875	15232	EE0000	OFF	OFF	OFF	ON	OFF	OFF	OFF	
15.000	15360	F00000	OFF	OFF	OFF	OFF	ON	ON	ON	
15.125	15488	F20000	OFF	OFF	OFF	OFF	ON	ON	OFF	
15.250	15616	F40000	OFF	OFF	OFF	OFF	ON	OFF	ON	
15.375	15744	F60000	OFF	OFF	OFF	OFF	ON	OFF	OFF	
15.500	15872	F80000	OFF	OFF	OFF	OFF	OFF	ON	ON	
15.625	16000	FA0000	OFF	OFF	OFF	OFF	OFF	ON	OFF	
15.750	16128	FC0000	OFF	OFF	OFF	OFF	OFF	OFF	ON	
15.875	16256	FE0000	OFF	OFF	OFF	OFF	OFF	OFF	OFF	

(This page intentionally left blank)

Configuring the AT System Board Memory

This operation needs to be performed only if you are doing one or more of the following things:

- You are installing the *Advantage!* in a 256K AT
- You are expanding a 256K AT system board to 512K by plugging in additional memory chips
- You are de-populating a 512K AT system board to 256K
- You are unsure whether or not the AT system board is properly configured

A jumper on the AT system board (J18) determines the maximum amount of memory the system board will accept. With the jumper in the 256K position, the system board will accept a maximum of 256K; with the jumper in the 512K position, the system board will accept a maximum of 512K.

This jumper *must* be in the correct position to ensure reliable AT operation:

- If you have 256K on your system board and you are installing a memory board like the *Advantage!*, the jumper must be in the 256K position.
- If you have 512K on your system board, the jumper must be in the 512K position.

The jumper is identified as "J18" and is located underneath the disk controller card at the very front of the AT chassis. Figure E-1 shows the location of this jumper and its two configuration positions.

Configuring the AT System Board Memory

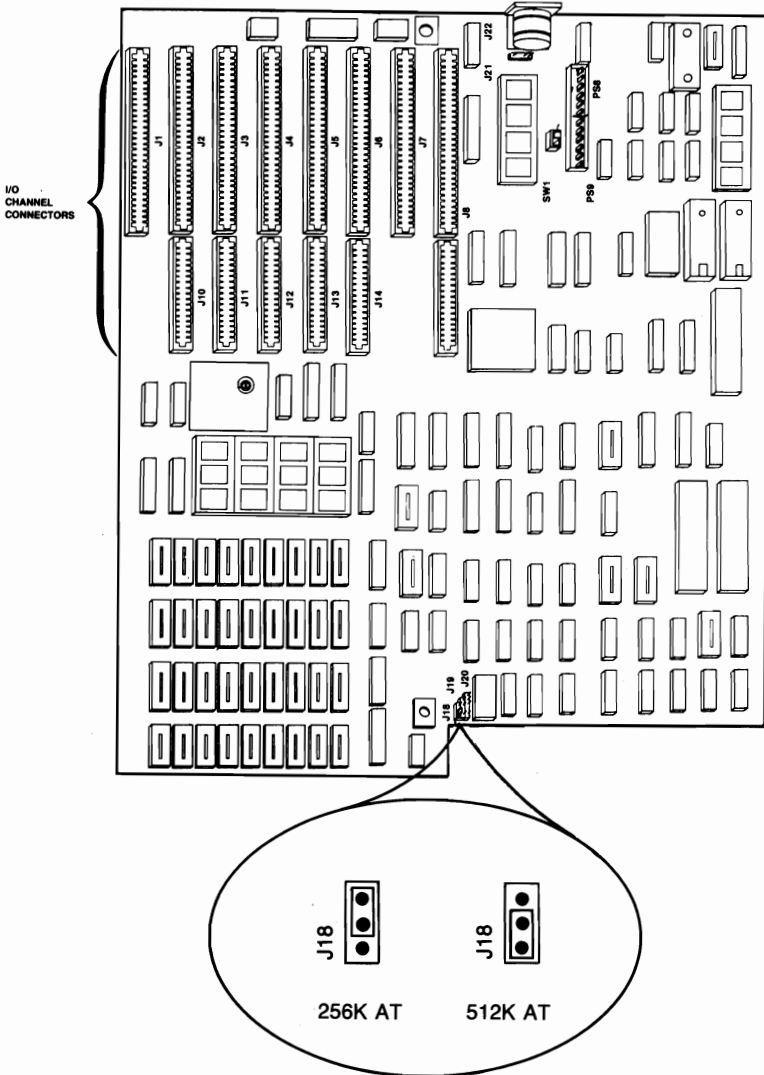

Figure E-1. AT System Board Memory Configuration

It may be necessary to lift the disk controller card up in order to gain access to the jumper. To do this, remove the screw securing the disk controller card bracket to the AT chassis and *carefully* lift up the card about 2 inches, being careful not to put excessive stress on the ribbon cables attached to the top of the card.

When you have the jumper correctly configured, be sure to re-install the disk controller card and secure the bracket to the AT chassis with the screw.

(This page intentionally left blank)

LIMITED WARRANTY

AST Research, Inc. warrants to the original purchaser of this AST Research, Inc. product that it is to be in good working order for a period of one year from the date of purchase from AST Research, Inc. or an authorized AST Research, Inc. dealer. Should this product, in AST Research, Inc.'s opinion, malfunction during the warranty period, AST will, at its option, repair or replace it at no charge, provided that the product has not been subjected to misuse, abuse, or non-AST authorized alterations, modifications, and/or repairs.

Products requiring Limited Warranty service during the warranty period should be delivered to AST with proof of purchase. If the delivery is by mail, you agree to insure the product or assume the risk of loss or damage in transit. You also agree to prepay shipping charges to AST.

ALL EXPRESS AND IMPLIED WARRANTIES FOR THIS PRODUCT INCLUDING, BUT NOT LIMITED TO, THE WARRANTIES OF MERCHANTABILITY AND FITNESS FOR A PARTICULAR PURPOSE, ARE LIMITED IN DURATION TO THE ABOVE ONE YEAR PERIOD. Some states do not allow limitations on how long an implied warranty lasts, so the above limitations may not apply to you.

UNDER NO CIRCUMSTANCES WILL AST RESEARCH, INC. BE LIABLE IN ANY WAY TO THE USER FOR DAMAGES, INCLUDING ANY LOST PROFITS, LOST SAVINGS, OR OTHER INCIDENTAL OR CONSEQUENTIAL DAMAGES ARISING OUT OF THE USE OF, OR INABILITY TO USE, SUCH PRODUCT. Some states do not allow the exclusion or limitation of incidental or consequential damages for consumer products, so the above limitations or exclusion may not apply to you.

THIS WARRANTY GIVES YOU SPECIFIC LEGAL RIGHTS, AND YOU MAY ALSO HAVE OTHER RIGHTS WHICH MAY VARY FROM STATE TO STATE.

The limited warranty applies to hardware products only.



AST RESEARCH, INC.

Product Comment Form

***Advantage!* User's Manual**

000179-001 C

We appreciate your comments regarding any problems or suggestions related to AST Research products. Please use this form to communicate any observations that you have concerning the improvement of either the product itself or the product documentation provided in this manual.

Submitter Information

Submitter's name:

Address:

Product/Manual Comments and Suggestions

Please mail this form to:

**AST Research, Inc.
Attn: Technical Publications
2121 Alton Avenue
Irvine, CA 92714**



IMPORTANT

All AST board-level products are warranted for two full years from date of purchase.

This note supercedes all references to the one-year warranty period contained in the enclosed manual(s). Please complete the enclosed Warranty Registration Form — AST will honor a two-year warranty period upon receipt of this form. Thank you.

000302-001



FCC WARNING

This equipment has been certified to comply with the limits for a Class B computing device, pursuant to Subpart J of Part 15 of FCC Rules. Only peripherals (computer input/output devices, terminals, printers, etc.) certified to comply with the Class B limits may be attached to a computer that complies with Class B limits. Operation with non-certified peripherals is likely to result in interference to radio and TV reception. When connecting to a peripheral device, a shielded I/O cable is required to ensure compliance with FCC Rules.

Instructions to User

This equipment generates and uses radio frequency energy and if not installed and used properly, that is, in strict accordance with the manufacturer's instructions, may cause interference to radio and television reception. It has been type tested and found to comply with the limits for a Class B computing device in accordance with the specifications in Subpart J of Part 15 of FCC Rules, which are designed to provide reasonable protection against such interference in a residential installation. However, there is no guarantee that interference will not occur in a particular installation. If this equipment does cause interference to radio or television reception, which can be determined by turning the equipment off and on, the user is encouraged to try to correct the interference by one or more of the following measures:

- Reorient the receiving antenna.
- Relocate the computer with respect to the receiver.
- Move the computer away from the receiver.
- Plug the computer into a different outlet so that computer and receiver are on different branch circuits.
- Ensure that board slot covers are in place when no board is installed.
- Ensure that all brackets are fastened securely to the PC chassis.

If necessary, the user should consult the dealer or an experienced radio/television technician for additional suggestions. The user may find the following booklet prepared by the Federal Communications Commission (FCC) helpful: "How to Identify and Resolve Radio-TV Interference Problems". This booklet is available from the U.S. Government Printing Office, Washington, DC 20402. Stock No. 004-000-00345-4.

Addendum
to
Advantage!™
User's Manual

000179-012 A
July, 1986

AST Research, Inc.
Irvine, California
(714) 863-1333

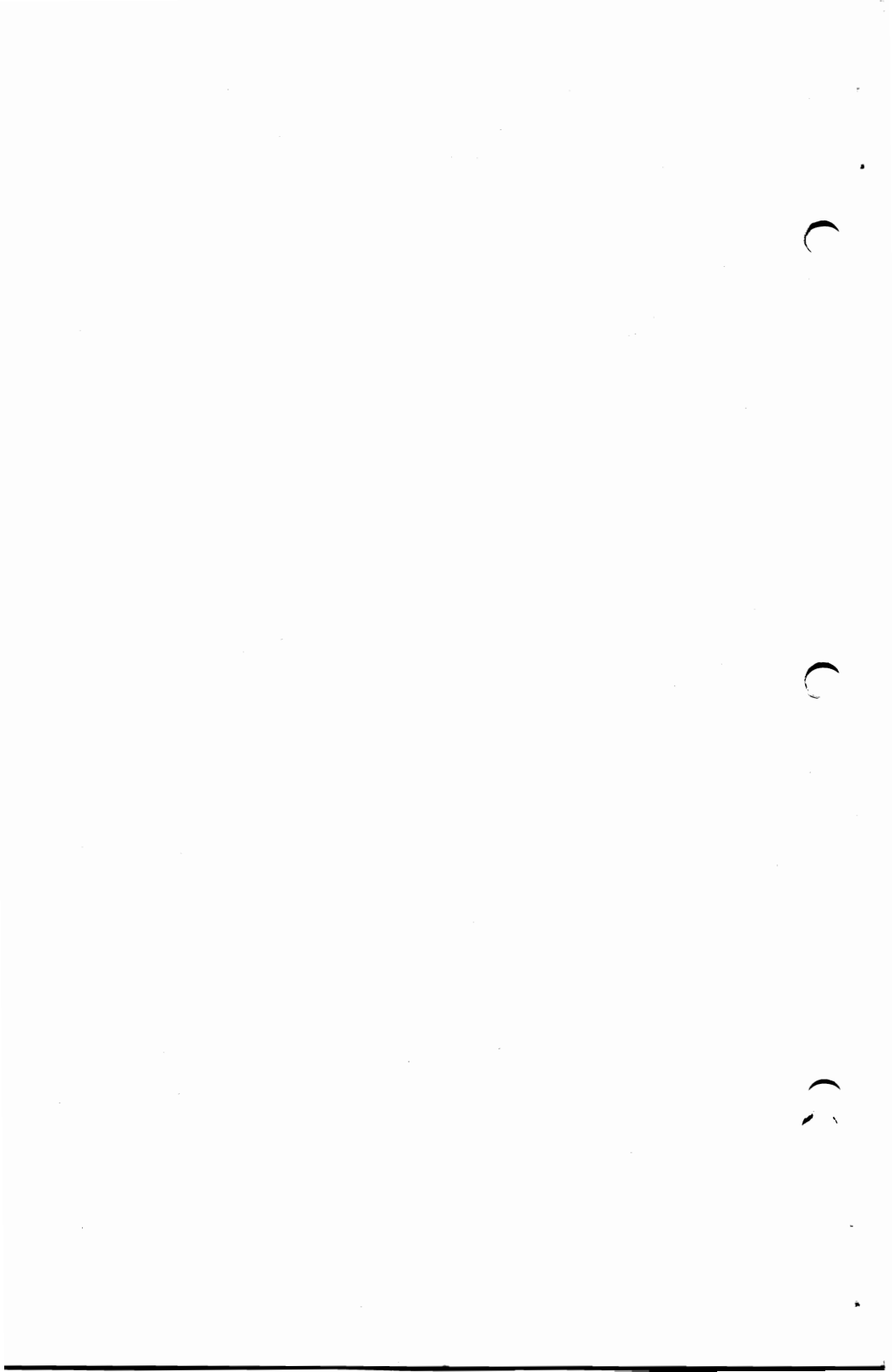

ADDENDUM TO THE

ADVANTAGE![™] USER'S MANUAL

This addendum adds necessary changes in the memory chip specification resulting from the use of 8 MHz PC-ATs.

Please replace the original pages with updated pages from this addendum as follows:

Original Pages

4-9 through 4-10
4-11 through 4-12

Updated Pages

4-9 through 4-10
4-11 through 4-12

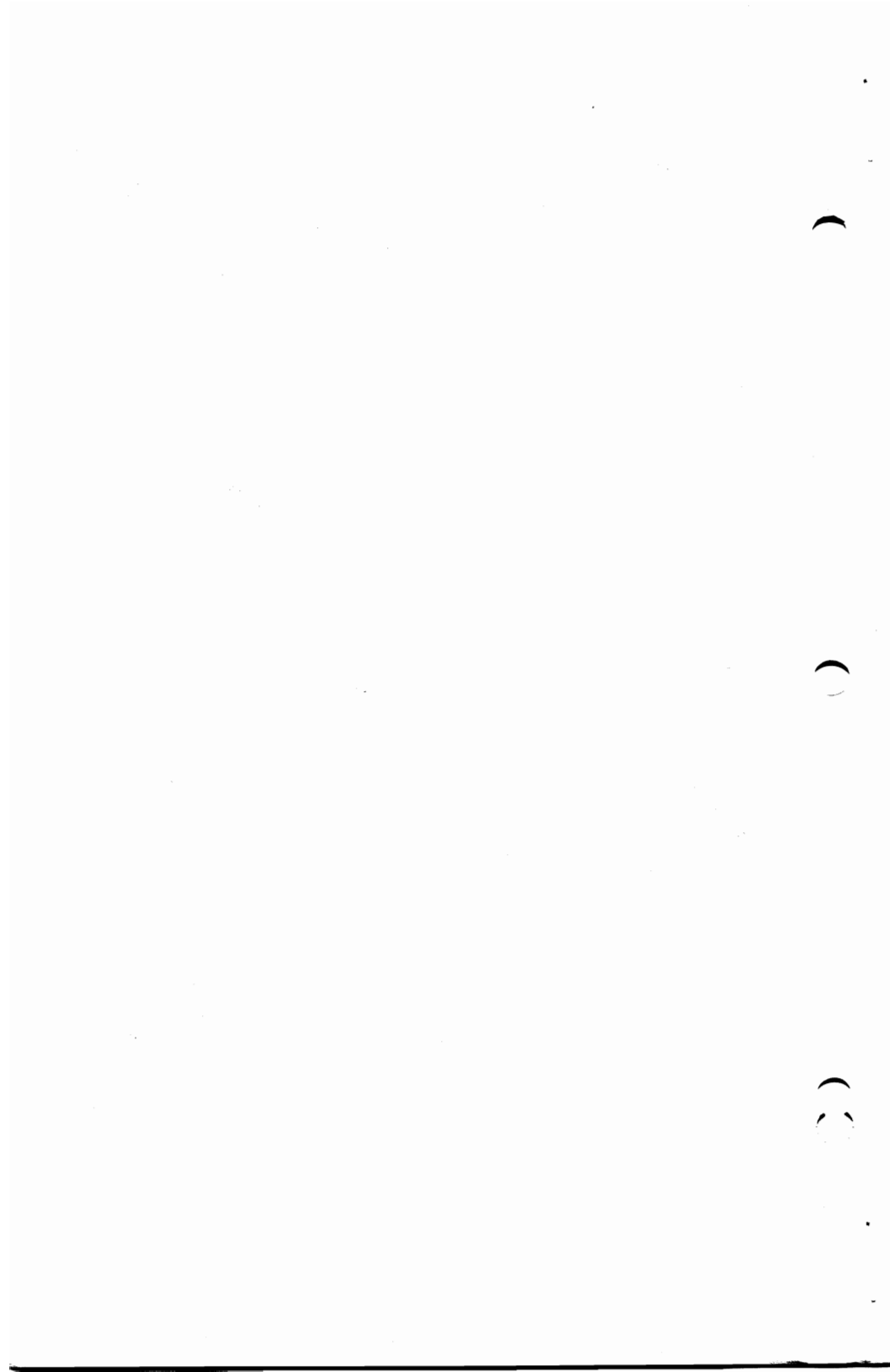

4.3.2 Installing a Card "Above" the *Advantage!*

To address another card "above" the *Advantage!*, follow this procedure:

STEP 1

Set the *Advantage!* starting address to one of the first three entries in the tables in Appendix D. Use the first entry if your AT has 256K on the system board. Use the second entry if your AT has 512K on the system board and you want to use Split Memory Addressing. Use the third entry if you do not want Split Memory Addressing or if you have the IBM 128K board.

STEP 2

Referring to the instructions supplied with the other card, set the other card's starting address to:

1 Megabyte plus the amount of *expansion* memory on the *Advantage!*

For example, if the *Advantage!* has 1.5 Megabytes of expansion memory on it, you would set the other card's starting address at 2.5 Megabytes, which is hexadecimal address :280000.

If you are using Split Memory Addressing on the *Advantage!*, remember that the amount of expansion memory is the total *Advantage!* memory minus the amount it contributes to the 640K user memory area. Using the above example, a 1.5 Megabyte *Advantage!* with Split Memory Addressing enabled in a 512K AT would have 1.375 Megabytes of expansion memory (1.5 MB minus 128K), so you would set the other card's starting address at 2.375 Megabytes (1 MB + 1.375 MB), which is hexadecimal address :260000.

STEP 3

Run the AT's SETUP program and configure it for the new amounts of (1) base memory and (2) expansion memory. You can use the tables in Appendix D to convert Megabytes to Kilobytes (SETUP requires information in Kilobytes).

4.4 Installing Additional Memory on the *Advantage!*

On the *Advantage!* and Advantage-Pak, a memory row which is populated with 18 64K memory chips contains 128K bytes of memory, while a row populated with 18 256K memory chips contains 512K bytes of memory:

(18) 64K Chips = 128K Bytes (64K 16-Bit Words)

(18) 256K Chips = 512K Bytes (256K 16-Bit Words)

An *Advantage!* or Advantage-Pak which is not fully populated can be upgraded with additional memory simply by plugging in additional memory chips. You can also upgrade from 64K chips to 256K chips. AST offers 128K memory upgrade kits for the *Advantage!* and Advantage-Pak, consisting of 18 64K chips; order AST part number MPAD-128. AST also offers 512K memory upgrade kits consisting of 18 256K chips; order AST part number MPAD-512.

4.4.1 Memory Chip Specifications

If you purchase memory chips from another source, be sure they meet the following specifications for use in either 8-MHz or 6-MHz PC-ATs.

64K Chip Specifications. User 64K Dynamic Random Access Memory (DRAM) with these characteristics:

120 nanosecond (ns) access time
Pin 1 not used
+5 Volt Only

The following 64K memory chips are compatible:

Fujitsu MB81464-12PZ
Micron MT4067Z-12

256K Chip Specifications. Use 256K Dynamic Random Access Memory (DRAM) with 120 nanosecond (ns) access time. The following manufacturer's 256K (120 ns) memory chips are compatible:

Fujitsu MB81256-12P
Hitachi HM50256P-12
Micron MT1257-12
Motorola MCM6256P-12
NEC UPD41256C-12
Samsung KM41256-12
Texas Instruments TMS4256-12NL
Toshiba TMM41256P-12

4.4.2 Populating the Memory Rows with Memory Chips

Figure 4-3 illustrates the arrangement of the rows of memory chips on the *Advantage!*.

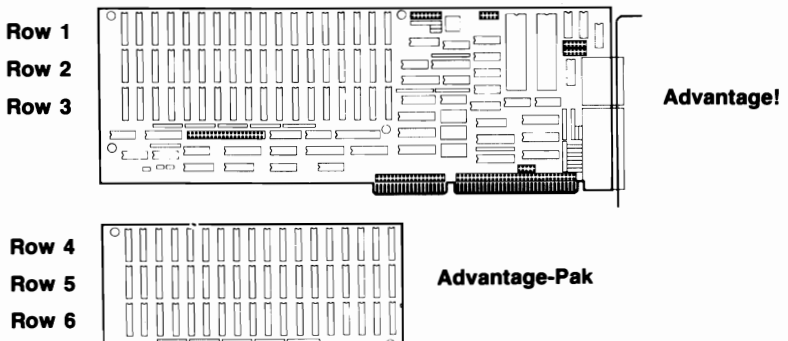

Figure 4-3. Memory Row Configuration.

The *Advantage!* main board can have up to three rows of memory on it, numbered 1, 2, and 3. The optional Advantage-Pak piggyback memory card provides additional rows of memory, numbered 4, 5, and 6. This provides up to 3 Megabytes in the space of a single AT expansion slot.

When adding memory to the *Advantage!* or Advantage-Pak, please note the following:

- The memory rows on the *Advantage!* and Advantage-Pak must be populated in sequential order. You cannot have an empty row of sockets in between two populated rows.
- Do not install the Advantage-Pak piggyback board unless all three rows on the *Advantage!* main board are fully populated.
- Whenever you add or remove memory on the *Advantage!*, be sure you re-adjust Switch Block #1 to reflect the new memory configuration on the card. This topic is discussed in Subsection 4.5.
- You must run the AT's SETUP program any time you add or remove memory from the AT.

4.4.3 Mixing 64K and 256K Memory Chips

When mixing 64K and 256K chips on the same board, please note the following:

- Each row of 18 chips must be populated entirely, using one type of chip. You cannot intermix 64K and 256K chips in the same row.
- Once a row of 256K chips is installed, all the following rows must use only 256K chips. For example, if you have 64K chips in Rows 1 and 2, and you install 256K chips in Row 3, then Rows 4 through 6 (on the Advantage-Pak) must all use 256K chips.